

# Product datasheet

Specifications



## Compact Drive System ATV660 - 500/400kW - 400 V - IP23

ATV660C50Q4X1

**Price: 1,123,122.31 ZAR**

### Main

Range of product	Altivar Process ATV600
Product specific application	Process and utilities
Product or component type	Variable speed drive
Device short name	ATV660
Product destination	Asynchronous motors Synchronous motors
Provided equipment	Enclosure PanelSeT SFN Graphical operating panel in the enclosure door Frequency inverter Main switch Line choke Terminal block main supply Terminal block motor
Colour of enclosure	Light grey (RAL 7035)
IP degree of protection	IP23 conforming to IEC 61800-5-1
Communication port protocol	EtherNet/IP Modbus TCP Modbus serial
Type of cooling	Forced convection
Supply frequency	50/60 Hz +/-5 %
[Us] rated supply voltage	380...415 V - 10...6 %
Network number of phases	3 phases
Output voltage	<= power supply voltage
Permissible temporary current boost	1.1 x In during 60 s (normal duty) 1.5 x In during 60 s (heavy duty)
Speed drive output frequency	0.1...500 Hz
Continuous output current	900 A at 2.5 kHz for normal duty 730 A at 2.5 kHz for heavy duty
Energy efficiency ratio	0.98
Power dissipation in W	13330 W, total (normal duty) 9800 W, total (heavy duty) 1530 W, control part (normal duty) 1020 W, control part (heavy duty)
Volume of cooling air	1740 m3/h for power 280 m3/h for control
Noise level	71 dB conforming to 86/188/EEC - physical agents (noise) directive
Motor power kW	500 kW for normal duty 400 kW for heavy duty
Prospective line Isc	50 kA for 100 ms

Excluding VAT and subject to change. Please check with your local distributor through "Where to buy"

<b>Motor recommended cable cross section</b>	5 x (3 x 120 mm <sup>2</sup> ) (normal duty) 4 x (3 x 185 mm <sup>2</sup> ) (normal duty) 3 x (3 x 185 mm <sup>2</sup> ) (heavy duty) 4 x (3 x 120 mm <sup>2</sup> ) (heavy duty)
<b>Option card</b>	Slot A: communication module, Profibus DP V1 Slot A: communication module, PROFINET Slot A: communication module, DeviceNet Slot A: communication module, Modbus TCP/EtherNet/IP Slot A: communication module, CANopen daisy chain RJ45 Slot A: communication module, CANopen SUB-D 9 Slot A: communication module, CANopen screw terminals Slot A/slot B: digital and analog I/O extension module Slot A/slot B: output relay extension module
<b>Safety function</b>	STO (safe torque off), level SIL 3 for <= 100 ms
<b>EMC filter</b>	Integrated conforming to IEC 61800-3, category C3, shielded cable with 150 m Integrated conforming to IEC 61800-3, category C4, unshielded cable with 250 m

## Complementary

<b>Discrete input number</b>	8
<b>Protection type</b>	Motor: thermal protection Motor: safe torque off Motor: motor phase break Drive: thermal protection Drive: safe torque off Drive: overheating Drive: overcurrent (between output phases and earth) Drive: overload (output) Drive: short-circuit protection Drive: motor phase break Drive: overvoltage (DC bus) Drive: line supply overvoltage Drive: line supply undervoltage Drive: line supply phase loss Drive: overspeed Drive: break on the control circuit Drive: short-circuit protection with semi-conductor fuse (main supply) Drive: fan monitoring
<b>Discrete input type</b>	DI1...DI6 programmable, 24 V DC (<= 30 V), impedance: 3.5 kOhm DI5, DI6 programmable as pulse input: 0...30 kHz, 24 V DC (<= 30 V) STOA, STOB safe torque off, 24 V DC (<= 30 V), impedance: > 2.2 kOhm
<b>Frequency resolution</b>	Display unit: 0.1 Hz Analog input: 0.012/50 Hz
<b>Connector type</b>	RJ45 (on the control block) for Modbus serial RJ45 (on the control block) for Ethernet IP/Modbus TCP
<b>Physical interface</b>	2-wire RS 485 for Modbus serial
<b>Transmission frame</b>	RTU for Modbus serial
<b>Transmission rate</b>	10/100 Mbit/s for Ethernet IP/Modbus TCP 4.8, 9.6, 19.2, 38.4 kbit/s for Modbus serial
<b>Exchange mode</b>	Half duplex, full duplex, autonegotiation Ethernet IP/Modbus TCP
<b>Data format</b>	8 bits, configurable odd, even or no parity for Modbus serial
<b>Type of polarization</b>	No impedance for Modbus serial
<b>Analogue input number</b>	3
<b>Number of addresses</b>	1...247 for Modbus serial
<b>Supply</b>	External supply for digital inputs: 24 V DC (10...30 V), <1.25 mA, protection type: overload and short-circuit protection Internal supply for reference potentiometer (1 to 10 kOhm): 10.5 V DC +/- 5 %, <10 mA, protection type: overload and short-circuit protection Internal supply for digital inputs and STO: 24 V DC (21...27 V), <200 mA, protection type: overload and short-circuit protection

<b>Analogue input type</b>	AI1, AI2, AI3 software-configurable voltage: 0...10 V DC, impedance: 30 kOhm, resolution 12 bits AI1, AI2, AI3 software-configurable current: 0...20 mA, impedance: 250 Ohm, resolution 12 bits
<b>Local signalling</b>	LCD display unit front door operation function, status and configuration
<b>Input compatibility</b>	DI1...DI6: discrete input level 1 PLC conforming to IEC 61131-2 DI5, DI6: discrete input level 1 PLC conforming to IEC 65A-68 STOA, STOB: discrete input level 1 PLC conforming to IEC 61131-2
<b>Analogue output number</b>	2
<b>Discrete input logic</b>	Positive logic (source) (DI1...DI6), < 5 V (state 0), > 11 V (state 1) Negative logic (sink) (DI1...DI6), > 16 V (state 0), < 10 V (state 1) Positive logic (source) (DI5, DI6), < 0.6 V (state 0), > 2.5 V (state 1) Positive logic (source) (STOA, STOB), < 5 V (state 0), > 11 V (state 1)
<b>Sampling duration</b>	2 ms +/- 0.5 ms (DI1...DI4) - discrete input 5 ms +/- 1 ms (DI5, DI6) - discrete input 5 ms +/- 1 ms (AI1, AI2, AI3) - analog input 10 ms +/- 1 ms (AQ1, AQ2) - analog output
<b>Analogue output type</b>	Software-configurable voltage AQ1, AQ2: 0...10 V DC impedance 470 Ohm, resolution 10 bits Software-configurable current AQ1, AQ2: 0...20 mA, resolution 10 bits
<b>Accuracy</b>	+/- 0.6 % AI1, AI2, AI3 for a temperature variation 60 °C analog input +/- 1 % AQ1, AQ2 for a temperature variation 60 °C analog output
<b>Linearity error</b>	AI1, AI2, AI3: +/- 0.15 % of maximum value for analog input AQ1, AQ2: +/- 0.2 % for analog output
<b>Relay output number</b>	3
<b>Refresh time</b>	Relay output (R1, R2, R3): 5 ms (+/- 0.5 ms)
<b>Isolation</b>	Between power and control terminals
<b>Relay output type</b>	Configurable relay logic R1: fault relay NO/NC electrical durability 100000 cycles Configurable relay logic R2: sequence relay NO electrical durability 100000 cycles Configurable relay logic R3: sequence relay NO electrical durability 100000 cycles
<b>Maximum switching current</b>	Relay output R1, R2, R3 on resistive load, cos phi = 1: 3 A at 250 V AC Relay output R1, R2, R3 on resistive load, cos phi = 1: 3 A at 30 V DC Relay output R1, R2, R3 on inductive load, cos phi = 0.4 and L/R = 7 ms: 2 A at 250 V AC Relay output R1, R2, R3 on inductive load, cos phi = 0.4 and L/R = 7 ms: 2 A at 30 V DC
<b>Minimum switching current</b>	Relay output R1, R2, R3: 5 mA at 24 V DC
<b>Method of access</b>	Slave Modbus TCP
<b>Asynchronous motor control profile</b>	Variable torque standard Constant torque standard Optimized torque mode
<b>Synchronous motor control profile</b>	Permanent magnet motor
<b>Acceleration and deceleration ramps</b>	S, U or customized Linear adjustable separately from 0.01 to 9000 s
<b>Motor slip compensation</b>	Automatic whatever the load Adjustable Not available in permanent magnet motor law Can be suppressed
<b>Switching frequency</b>	2...8 kHz adjustable with derating factor
<b>Nominal switching frequency</b>	2.5 kHz
<b>Braking to standstill</b>	By DC injection
<b>Line current</b>	846 A at 400 V (normal duty) 681 A at 400 V (heavy duty)
<b>Apparent power</b>	586 kVA at 400 V (normal duty) 472 kVA at 400 V (heavy duty)

<b>Maximum transient current</b>	990 A during 60 s per 10 min (normal duty) 1095 A during 60 s per 10 min (heavy duty)
<b>Short-circuit protection</b>	Internal: 400 A 3 aR fuse Upstream: 1000 A gG fuse (normal duty) Upstream: 800 A gG fuse (heavy duty)
<b>Electrical connection</b>	Removable screw terminals, clamping capacity: 0.5...1.5 mm <sup>2</sup> for control M12 bar for main supply M12 bar for motor
<b>cable entry</b>	Bottom
<b>Width</b>	800 mm
<b>Height</b>	2150 mm
<b>Depth</b>	664 mm
<b>Net weight</b>	650 kg

## Environment

<b>Insulation resistance</b>	> 1 MOhm 500 V DC for 1 minute to earth
<b>Pollution degree</b>	2 conforming to IEC 61800-5-1
<b>Vibration resistance</b>	1.5 mm peak to peak (f= 3...10 Hz) conforming to IEC 60068-2-6 0.6 gn (f= 10...200 Hz) conforming to IEC 60068-2-6 3M3 conforming to IEC 60721-3-3
<b>Shock resistance</b>	4 gn for 11 ms conforming to IEC 60068-2-27 3M2 conforming to IEC 60721-3-3
<b>Relative humidity</b>	5...95 % without condensation conforming to IEC 60068-2-3
<b>Operating altitude</b>	< 1000 m without derating 1000...2000 m with current derating 1 % per 100 m 2000...3800 m with current derating 1 % per 100 m for TT earthing system 2000...3800 m with current derating 1 % per 100 m for TN earthing system 2000...3800 m with current derating 1 % per 100 m for IT earthing system 3800...4800 m with current derating 1 % per 100 m for TT earthing system 3800...4800 m with current derating 1 % per 100 m for TN earthing system
<b>Environmental characteristic</b>	Chemical pollution resistance class 3C3 conforming to IEC 60721-3-3 Dust pollution resistance class 3S3 conforming to IEC 60721-3-3 Humidity resistant class 3K3 conforming to IEC 60721-3-3
<b>Operating position</b>	Vertical +/- 10 degree
<b>Product certifications</b>	ATEX EAC C-Tick
<b>Marking</b>	CE
<b>Standards</b>	IEC 60204-1 IEC 61800-2 IEC 61800-3 IEC 61800-5-1
<b>Maximum THDI</b>	<39 % full load conforming to IEC 61000-3-12
<b>Assembly style</b>	In floor-standing enclosure compact version
<b>Electromagnetic compatibility</b>	Electrostatic discharge immunity test level 3 conforming to IEC 61000-4-2 Radiated radio-frequency electromagnetic field immunity test level 3 conforming to IEC 61000-4-3 Electrical fast transient/burst immunity test level 4 conforming to IEC 61000-4-4 1.2/50 µs - 8/20 µs surge immunity test level 3 conforming to IEC 61000-4-5 Conducted radio-frequency immunity test level 3 conforming to IEC 61000-4-6
<b>Overvoltage category</b>	III
<b>Ambient air temperature for operation</b>	-10...0 °C without derating (with option enclosure heating) 0...40 °C without derating 40...50 °C with derating factor

---

Ambient air temperature for storage -25...70 °C

## Packing Units

---

Unit Type of Package 1	PCE
------------------------	-----

---

Number of Units in Package 1	1
------------------------------	---

---

Package 1 Height	236 cm
------------------	--------

---

Package 1 Width	1000 cm
-----------------	---------

---

Package 1 Length	90 cm
------------------	-------

---

Package 1 Weight	680 kg
------------------	--------

## Contractual warranty

---

Warranty (in months)	18
----------------------	----



## Environmental Data

Schneider Electric aims to achieve Net Zero status by 2050 through supply chain partnerships, lower impact materials, and circularity via our ongoing “Use Better, Use Longer, Use Again” campaign to extend product lifetimes and recyclability.

[Environmental Data explained >](#)

[How we assess product sustainability >](#)

### Environmental footprint

Total lifecycle Carbon footprint 433047

Environmental Disclosure [Product Environmental Profile](#)

## Use Better

### Materials and Substances

Packaging made with recycled cardboard No

Packaging without single use plastic No

[EU RoHS Directive](#) Pro-active compliance (Product out of EU RoHS legal scope)

SCIP Number D85bea05-cdd1-41b2-b42a-71d8bf09d77f

REACH Regulation [REACH Declaration](#)

## Use Longer

### Lifetime extension

Repair No

Product repair index A

## Use Again

### Repack and remanufacture

End of life manual availability [End of Life Information](#)

Take-back No

Dimensions Drawings

Dimensions

Right and Front Views

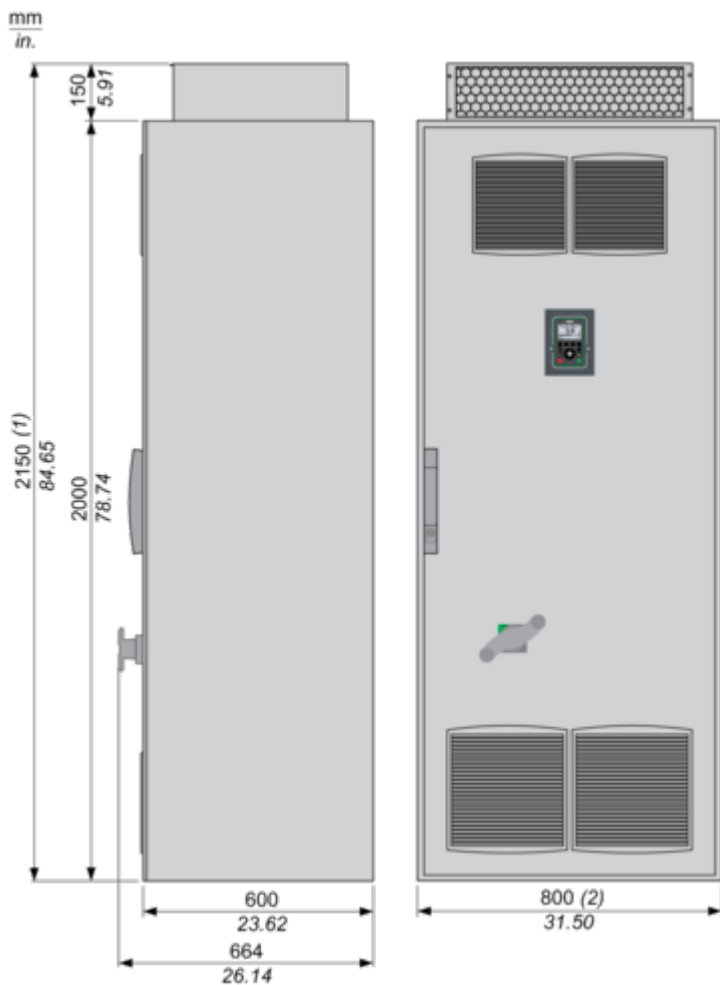

(1) + 200 mm / 7.87 in. with option enclosure plinth or increased protection degree IP54

(2) + 600 mm / 23.62 in. with option connection enclosure cable from top/bottom

Mounting and Clearance

Mounting and Clearance

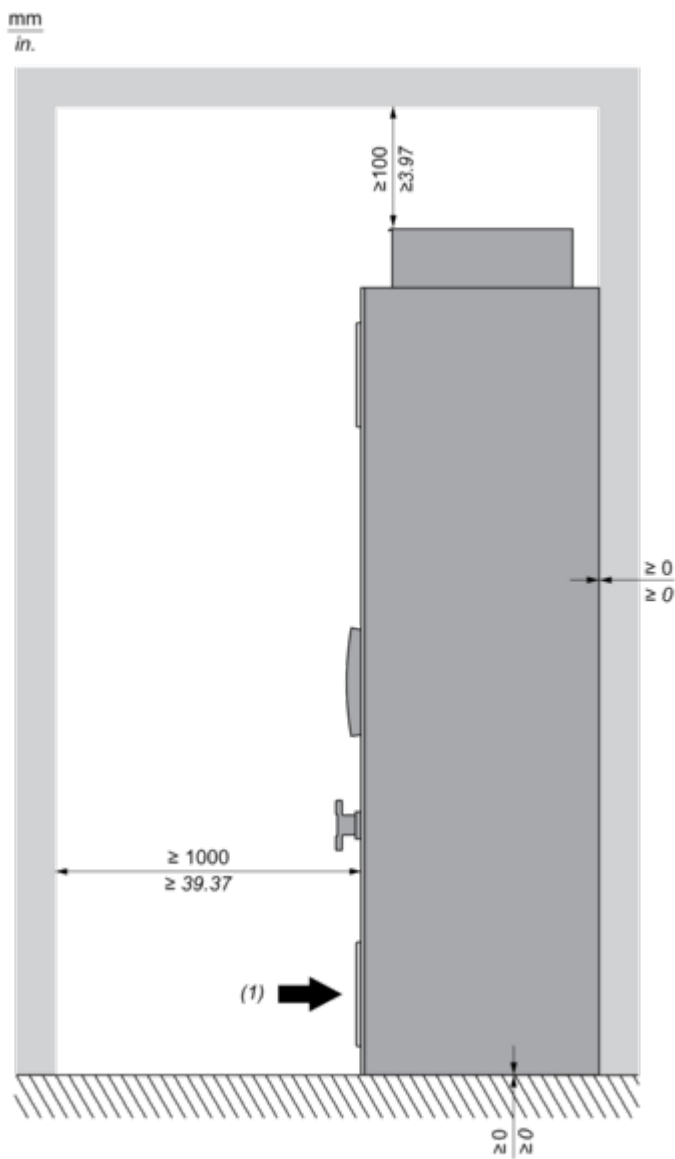

Connections and Schema

Typical Wiring Diagram of the Frequency Inverter

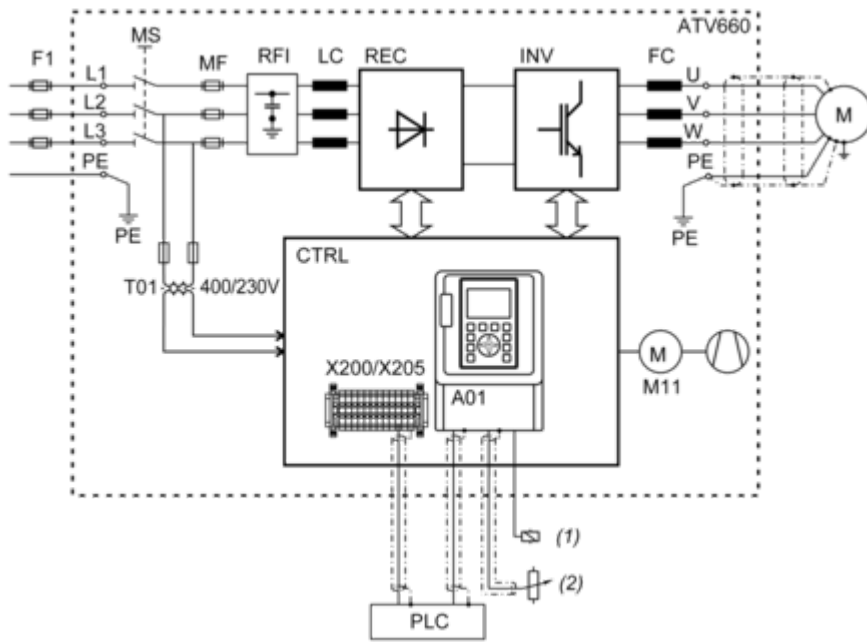

- F1** External pre-fuse or circuit breaker
- MS** Built-in main switch
- T01** Control transformer 400 / 230 V AC
- MF** aR fuses
- RFI** Built-in RFI filter
- LC** Line reactor choke
- REC** Rectifier module
- INV** Inverter module
- FC** dv/dt filter (from 355 kW the dv/dt filter choke 150 m is built-in as standard)
- CTRL** Control panel
- A01** Control terminals at the control block
- X200 / X205** Control terminals at the control panel (depending on the chosen options)
- M11** Fan in enclosure door
- (1)** Relay control
- (2)** Reference value

Structure of the Control Block

---

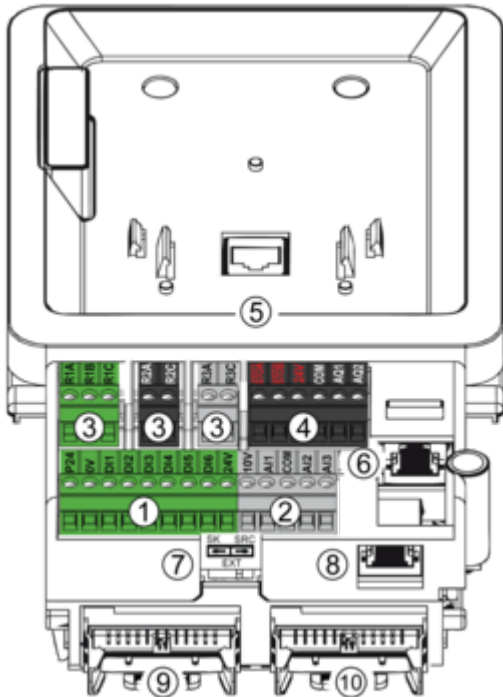

- (1) Digital inputs
- (2) Analog inputs
- (3) Relay outputs
- (4) STO (Safe Torque Off) and analog outputs
- (5) RJ45 port for door mounting kit of the graphic keypad
- (6) RJ45 port for Ethernet IP or Modbus TCP
- (7) Sink-Ext-Source selector switch (see switch configuration below)
- (8) RJ45 port for serial Modbus
- (9) Slot for I/O expansion card
- (10) Slot for fieldbus or I/O expansion card

Control Block Wiring Diagram

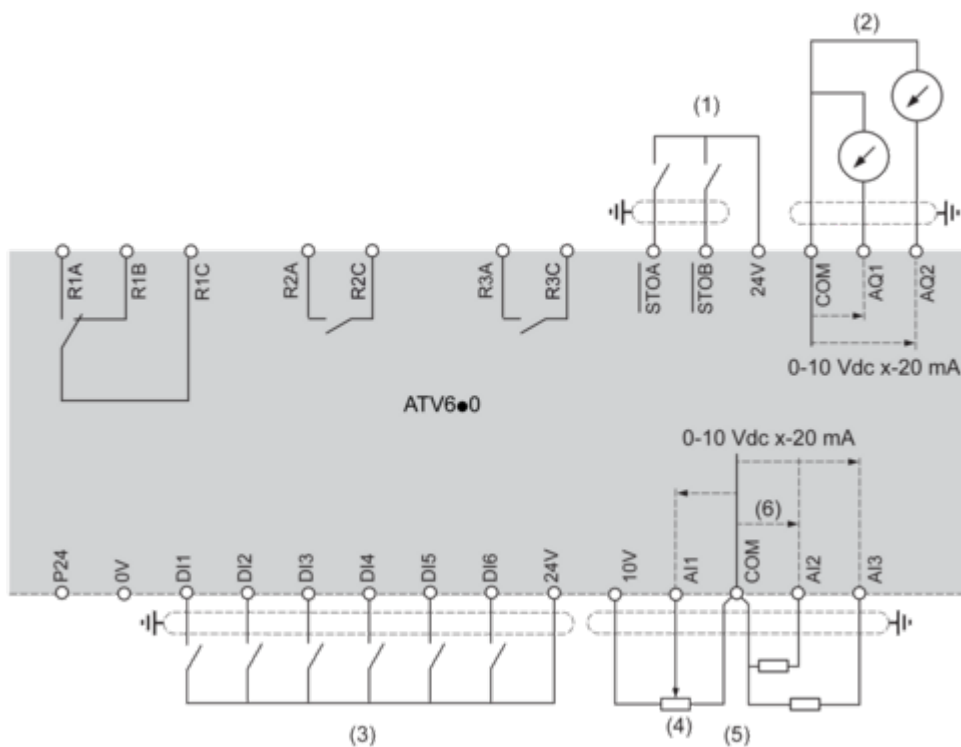

- (1) Safe Torque Off
- (2) Analog Output
- (3) Digital Input
- (4) Reference potentiometer
- (5) Analog Input
- R1A, R1B, R1C : Fault relay
- R2A, R2C : Sequence relay
- R3A, R3C : Sequence relay

Sensor Connection

It is possible to connect either 1 or 3 sensors on terminals AI2 or AI3.

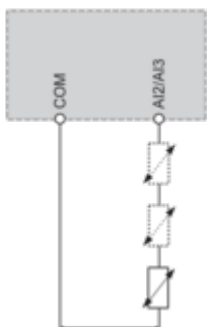

**Sink / Source Switch Configuration**

The switch is used to adapt the operation of the logic inputs to the technology of the programmable controller outputs.

- Set the switch to Source (factory setting) if using PLC outputs with PNP transistors.
- Set the switch to Ext if using PLC outputs with NPN transistors.

**Switch Set to SRC (Source) Position Using the Output Power Supply for the Digital Inputs**

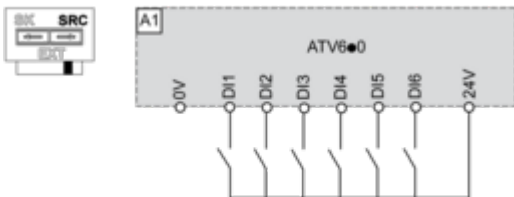

**Switch Set to SRC (Source) Position and Use of an External Power Supply for the DIs**

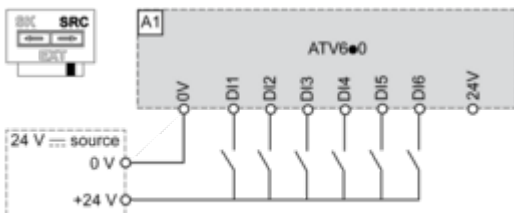

**Switch Set to SK (Sink) Position Using the Output Power Supply for the Digital Inputs**

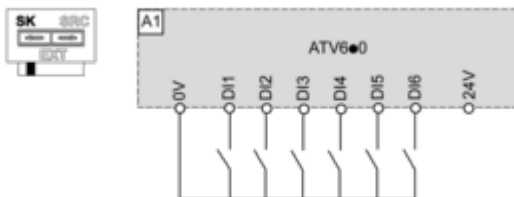

**Switch Set to EXT Position Using an External Power Supply for the DIs**

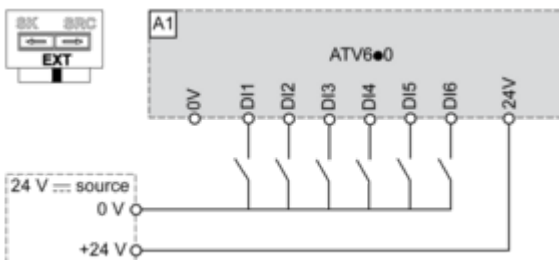

Performance Curves

Derating Curves

---

Normal Duty



In : Nominal Drive Current  
 SF : Switching Frequency

Heavy Duty



In : Nominal Drive Current  
 SF : Switching Frequency

Technical Illustration

Dimensions

---

