

Product datasheet

Specifications



Circuit breaker, GoPact MCCB 125,
4 poles, 30kA at 415VAC, 40A
rating, TMD trip unit, fixed thermal
protection

G12F4F40

Price: 1,916.17 ZAR

Main

Range of product	GoPact MCCB
Product or component type	Circuit breaker
Product name	GoPact MCCB 125
Device application	Distribution
Poles description	4P
Protected poles description	4D
Neutral position	Left
[In] rated current	40 A at 40 °C
[Ue] rated operational voltage	415 V AC 50/60 Hz conforming to EN/IEC 60947-2
Suitability for isolation	Yes conforming to EN/IEC 60947-2
Utilisation category	Category A
[Icu] rated ultimate short-circuit breaking capacity	30 kA Icu at 380/415 V AC 50/60 Hz conforming to EN/IEC 60947-2 50 kA Icu at 220/230 V AC 50/60 Hz conforming to EN/IEC 60947-2
Performance level	F 30 kA 380/415 V AC
Trip unit name	TM-D
Trip unit technology	Thermal-magnetic
Trip unit protection functions	LI
Control type	Toggle
Circuit breaker mounting mode	Fixed

Complementary

[Ui] rated insulation voltage	440 V AC conforming to EN/IEC 60947-2
[Uimp] rated impulse withstand voltage	6 kV conforming to EN/IEC 60947-2
[Ics] rated service short-circuit breaking capacity	15 kA at 380/415 V AC 50/60 Hz conforming to EN/IEC 60947-2 25 kA at 220/230 V AC 50/60 Hz conforming to EN/IEC 60947-2
Mechanical durability	30000 cycles
Electrical durability	8000 cycles at 415 V In
Power dissipation per pole	18.7 W
Mounting support	Backplate
Mounting position	Horizontal and vertical Flat on the back
Upside connection	Front

Excluding VAT and subject to change. Please check with your local distributor through "Where to buy"

Downside connection	Front
Connection terminals	screw terminals
Connection pitch	25 mm
Protection type	L : for overload protection (thermal) I : for short-circuit protection (magnetic)
Trip unit rating	40 A at 40 °C
Long-time pick-up adjustment type Ir (thermal protection)	Fixed
[Ir] long-time protection pick-up adjustment range	1 x In
Long-time protection delay adjustment type tr	Fixed
Instantaneous protection pick-up adjustment type Ii	Fixed
[Ii] instantaneous protection pick-up adjustment range	10 x In
Neutral protection settings	1 x Ir (4D)
Width (W)	100 mm
Height (H)	130 mm
Depth (D)	60 mm
Net weight	0.9 kg
Colour	Grey (RAL 7035)

Environment

Standards	EN/IEC 60947-1 EN/IEC 60947-2 EN/IEC 60947-2 Annex H
Overvoltage category	III
Pollution degree	3 conforming to IEC 60664-1
IP degree of protection	IP20 conforming to IEC 60529
Ambient air temperature for operation	-20...55 °C
Ambient air temperature for storage	-35...85 °C
Operating altitude	0...2000 m without derating 2000...5000 m with derating

Packing Units

Unit Type of Package 1	PCE
Number of Units in Package 1	1
Package 1 Height	12.4 cm
Package 1 Width	11 cm
Package 1 Length	13.9 cm
Package 1 Weight	1187 g
Unit Type of Package 2	S02
Number of Units in Package 2	6
Package 2 Height	15 cm
Package 2 Width	30 cm
Package 2 Length	40 cm

Package 2 Weight	7.437 kg
Unit Type of Package 3	P06
Number of Units in Package 3	96
Package 3 Height	75 cm
Package 3 Width	60 cm
Package 3 Length	80 cm
Package 3 Weight	127.492 kg

Contractual warranty

Warranty (in months)	18
-----------------------------	----



Environmental Data

Schneider Electric aims to achieve Net Zero status by 2050 through supply chain partnerships, lower impact materials, and circularity via our ongoing “Use Better, Use Longer, Use Again” campaign to extend product lifetimes and recyclability.

[Environmental Data explained >](#)

[How we assess product sustainability >](#)



Environmental footprint

Total lifecycle Carbon footprint 669 kg CO2 eq.

Environmental Disclosure [Product Environmental Profile](#)

Use Better



Materials and Substances

Packaging made with recycled cardboard Yes

Packaging without single use plastic No, we have minimized the use of plastic in the packaging in compliance with regulations and considering quality and safety standards

[EU RoHS Directive](#) Compliant with Exemptions

SCIP Number 7ccb5ff0-1063-42f0-88cf-9573d7504038

REACH Regulation [REACH Declaration](#)

Halogen-free status Halogen free plastic parts product

PVC free Yes

Silicone-free Yes

Use Longer



Lifetime extension

Repair No

Use Again



Repack and remanufacture

End of life manual availability [End of Life Information](#)

Take-back No

Technical Illustration

Dimensions

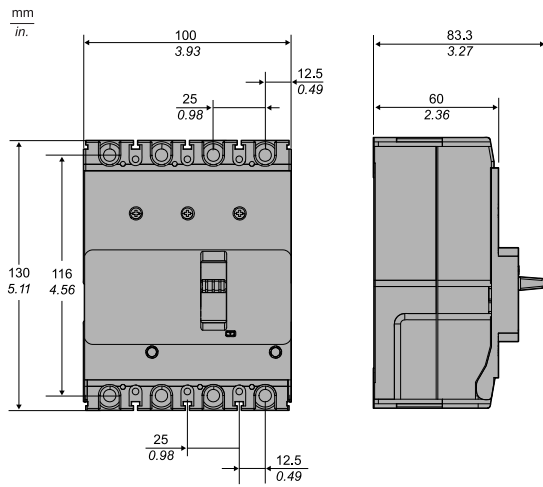

Offer Marketing Illustration

Product benefits / Features

GoPact MCCB

Technical Benefits



- Complete range from 16 to 800 A
- Complete portfolio of accessories: Electrical auxiliaries, Insulation auxiliaries, Connection accessories, Control accessories, Internal accessories.
- GoPact MTS range covers ratings from 63A to 2000A in 6 frame sizes.
- Built-in trip unit
- Sufficient pole pitch helps to terminate copper busbars or cables
- It has a good price-performance ratio for simple applications and delivers a reliable electrical solution for your applications.
- Schneider Electric performance, quality, and warranty

Offer Marketing Illustration

Product benefits / Features



GoPact MCCB Range Accessories



Rotary handles



Auxiliary contact



Terminal extensions



MN undervoltage release



Rear connectors



Short terminal shield



Plug in conversion kit



Plug in base



Interphase barrier



Bare cable connector

Offer Marketing Illustration

Product benefits / Features

GoPact MCCB Technical Features



Offer Marketing Illustration

Product benefits / Features

GoPact MCCB

Molded Case Circuit Breakers



Affordable

Multiple choices are available between current rating and tripping technology, enabling you to optimize the purchase vs. performance cost.



Reliable Performance

Robust breaker for an enduring mechanical and electrical life.



Available Everywhere

Accessible both in distributor stores and across various e-commerce platforms.

Offer Marketing Illustration

Product benefits / Features

GoPact MCCB

Molded Case Circuit Breakers



Affordable

Multiple choices are available between current rating and tripping technology, enabling you to optimize the purchase vs. performance cost.



Reliable Performance

Robust breaker for an enduring mechanical and electrical life.



Available Everywhere

Accessible both in distributor stores and across various e-commerce platforms.