

Product datasheet

Specifications



Variable speed drive. Altivar Process ATV600. ATV630. 160 kW. 380...440 V. IP21

ATV630C16N4F

Price: 430,494.16 ZAR

Main

Range of product	Altivar Process ATV600
Product specific application	Process and utilities
Product or component type	Variable speed drive
Variant	Standard version
Device short name	ATV630
Mounting mode	Floor-standing
Communication port protocol	Ethernet Modbus TCP Modbus serial
[Us] rated supply voltage	380...440 V - 15...10 %
[Us] rated supply voltage	380...440 V
Relative symmetric mains voltage tolerance	10 %
Relative symmetric network frequency tolerance	5 %
nominal output current	302.0 A
IP degree of protection	IP21
Product destination	Asynchronous motors Synchronous motors
EMC filter	Integrated with 150 m conforming to IEC 61800-3 category C3
IP degree of protection	IP21 conforming to IEC 61800-5-1 IP21 conforming to IEC 60529
Type of cooling	Forced convection
Supply frequency	50...60 Hz - 5...5 %
Motor power kW	160 kW (normal duty) 132 kW (heavy duty)
Line current	251 A at 400 V (normal duty) 210 A at 400 V (heavy duty) 291 A at 380 V (normal duty) 244 A at 380 V (heavy duty)
Continuous output current	302 A at 2.5 kHz for normal duty 250 A at 2.5 kHz for heavy duty
Speed drive output frequency	0.1...500 Hz
Safety function	STO (safe torque off) SIL 3

Excluding VAT and subject to change. Please check with your local distributor through "Where to buy"

Option card	Slot A: communication module, Profibus DP V1 Slot A: communication module, PROFINET Slot A: communication module, DeviceNet Slot A: communication module, Modbus TCP/EtherNet/IP Slot A: communication module, CANopen daisy chain RJ45 Slot A: communication module, CANopen SUB-D 9 Slot A: communication module, CANopen screw terminals Slot A/slot B: digital and analog I/O extension module Slot A/slot B: output relay extension module Slot A: communication module, Ethernet IP/Modbus TCP/MD-Link Communication module, BACnet MS/TP Communication module, Ethernet Powerlink
--------------------	---

Complementary

Discrete input number	8
Discrete input type	DI7, DI8 programmable as pulse input: 0...30 kHz, 24 V DC (<= 30 V)
Discrete input logic	16 preset speeds
Discrete output number	0
Discrete output type	Relay outputs R1A, R1B, R1C 250 V AC 3000 mA Relay outputs R1A, R1B, R1C 30 V DC 3000 mA Relay outputs R2A, R2C 250 V AC 5000 mA Relay outputs R2A, R2C 30 V DC 5000 mA Relay outputs R3A, R3C 250 V AC 5000 mA Relay outputs R3A, R3C 30 V DC 5000 mA
Analogue input number	3
Analogue input type	AI1, AI2, AI3 software-configurable voltage: 0...10 V DC, impedance: 31.5 kOhm, resolution 12 bits AI1, AI2, AI3 software-configurable current: 0...20 mA, impedance: 250 Ohm, resolution 12 bits AI2 voltage analog input: - 10...10 V DC, impedance: 31.5 kOhm, resolution 12 bits
Analogue output number	2
Analogue output type	Software-configurable voltage AQ1, AQ2: 0...10 V DC impedance 470 Ohm, resolution 10 bits Software-configurable current AQ1, AQ2: 0...20 mA, resolution 10 bits Software-configurable current DQ-, DQ+: 30 V DC Software-configurable current DQ-, DQ+: 100 mA
Relay output number	3
Relay output type	Configurable relay logic R1: fault relay NO/NC electrical durability 100000 cycles Configurable relay logic R2: sequence relay NO electrical durability 100000 cycles Configurable relay logic R3: sequence relay NO electrical durability 100000 cycles
Maximum switching current	Relay output R1, R2, R3 on resistive load, cos phi = 1: 3 A at 250 V AC Relay output R1, R2, R3 on resistive load, cos phi = 1: 3 A at 30 V DC Relay output R1, R2, R3 on inductive load, cos phi = 0.4 and L/R = 7 ms: 2 A at 250 V AC Relay output R1, R2, R3 on inductive load, cos phi = 0.4 and L/R = 7 ms: 2 A at 30 V DC
Minimum switching current	Relay output R1, R2, R3: 5 mA at 24 V DC
Network number of phases	3 phases
Physical interface	Ethernet 2-wire RS 485
Method of access	Slave Modbus TCP
Transmission rate	10, 100 Mbits 4800 bps, 9600 bps, 19200 bps, 38.4 Kbps
Transmission frame	RTU
Output voltage	<= power supply voltage
Permissible temporary current boost	1.1 x I _n during 60 s (normal duty) 1.5 x I _n during 60 s (heavy duty)
Data format	8 bits, configurable odd, even or no parity

Type of polarization	No impedance
Frequency resolution	Display unit: 0.1 Hz Analog input: 0.012/50 Hz
Electrical connection	Control: removable screw terminals 0.5...1.5 mm ² Line side: M12 bar - 1 cables 3 x 185 mm ² maximum per phase (normal duty) Line side: M12 bar - 2 cables 3 x 120 mm ² maximum per phase (normal duty) Motor: M12 bar - 2 cables 3 x 185 mm ² maximum per phase (normal duty) Line side: M12 bar - 2 cables 3 x 70 mm ² minimum per phase (heavy duty) Line side: M12 bar - 1 cables 3 x 185 mm ² maximum per phase (heavy duty) Line side: M12 bar - 2 cables 3 x 120 mm ² maximum per phase (heavy duty) Motor: M12 bar - 2 cables 3 x 185 mm ² maximum per phase (heavy duty) Line side: M12 bar - 1 cables 3 x 185 mm ² minimum per phase (normal duty) Line side: M12 bar - 1 cables 3 x 185 mm ² minimum per phase (heavy duty) Line side: M12 bar - 2 cables 3 x 95 mm ² minimum per phase (normal duty) Motor: M12 bar - 1 cables 3 x 185 mm ² minimum per phase (normal duty) Motor: M12 bar - 2 cables 3 x 95 mm ² minimum per phase (normal duty) Motor: M12 bar - 1 cables 3 x 150 mm ² minimum per phase (heavy duty) Motor: M12 bar - 2 cables 3 x 70 mm ² minimum per phase (heavy duty)
Connector type	RJ45 (on the remote graphic terminal) for Ethernet/Modbus TCP RJ45 (on the remote graphic terminal) for Modbus serial
Exchange mode	Half duplex, full duplex, autonegotiation Ethernet/Modbus TCP
Number of addresses	1...247 for Modbus serial
Supply	External supply for digital inputs: 24 V DC (19...30 V), <1.25 mA, protection type: overload and short-circuit protection Internal supply for reference potentiometer (1 to 10 kOhm): 10.5 V DC +/- 5 %, <10 mA, protection type: overload and short-circuit protection Internal supply for digital inputs and STO: 24 V DC (21...27 V), <200 mA, protection type: overload and short-circuit protection
Local signalling	3 LEDs for local diagnostic 3 LEDs (dual colour) for embedded communication status 4 LEDs (dual colour) for communication module status 1 LED (red) for presence of voltage
Input compatibility	DI1...DI6: discrete input level 1 PLC conforming to IEC 61131-2 DI5, DI6: discrete input level 1 PLC conforming to IEC 65A-68 STOA, STOB: discrete input level 1 PLC conforming to IEC 61131-2
Discrete input logic	Positive logic (source) (DI1...DI8), < 5 V (state 0), > 11 V (state 1) Negative logic (sink) (DI1...DI8), > 16 V (state 0), < 10 V (state 1)
Sampling duration	2 ms +/- 0.5 ms (DI1...DI4) - discrete input 5 ms +/- 1 ms (DI5, DI6) - discrete input 5 ms +/- 0.1 ms (AI1, AI2, AI3) - analog input 10 ms +/- 1 ms (AO1) - analog output
Accuracy	+/- 0.6 % AI1, AI2, AI3 for a temperature variation 60 °C analog input +/- 1 % AO1, AO2 for a temperature variation 60 °C analog output
Linearity error	AI1, AI2, AI3: +/- 0.15 % of maximum value for analog input AO1, AO2: +/- 0.2 % for analog output
Refresh time	Relay output (R1, R2, R3): 5 ms (+/- 0.5 ms)
Isolation	Between power and control terminals

Discrete and process manufacturing	Building - HVAC compressor centrifugal Food and beverage processing other application Mining mineral and metal fan Mining mineral and metal pump Oil and gas fan Water and waste water other application Building - HVAC screw compressor Food and beverage processing pump Food and beverage processing fan Food and beverage processing atomization Oil and gas electro submersible pump (ESP) Oil and gas water injection pump Oil and gas jet fuel pump Oil and gas compressor for refinery Water and waste water centrifuge pump Water and waste water positive displacement pump Water and waste water electro submersible pump (ESP) Water and waste water screw pump Water and waste water lobe compressor Water and waste water screw compressor Water and waste water compressor centrifugal Water and waste water fan Water and waste water conveyor Water and waste water mixer
Power range	110...220 kW at 380...440 V 3 phases
Enclosure mounting	Floor-standing
4 quadrant operation possible	False
Asynchronous motor control profile	Constant torque standard Optimized torque mode Variable torque standard
Synchronous motor control profile	Permanent magnet motor Synchronous reluctance motor
Maximum output frequency	500 kHz
Acceleration and deceleration ramps	Linear adjustable separately from 0.01...9999 s
Motor slip compensation	Adjustable Can be suppressed Not available in permanent magnet motor law Automatic whatever the load
Switching frequency	2.5...8 kHz with derating factor 2...8 kHz adjustable
Nominal switching frequency	2.5 kHz
Braking to standstill	By DC injection
Brake chopper integrated	False
Maximum input current	291.0 A
Maximum output voltage	440.0 V
Apparent power	191 kVA at 440 V (normal duty) 160 kVA at 440 V (heavy duty)
Maximum transient current	332 A during 60 s (normal duty) 375 A during 60 s (heavy duty)
Network frequency	50...60 Hz
Prospective line I_{sc}	50 kA
Base load current at high overload	250.0 A
Base load current at low overload	302.0 A
Power dissipation in W	3120 W, switching frequency 2.5 kHz (normal duty) 4030 W, switching frequency 2.5 kHz (heavy duty)
With safety function Safely Limited Speed (SLS)	False

With safety function Safe brake management (SBC/SBT)	False
With safety function Safe Operating Stop (SOS)	False
With safety function Safe Position (SP)	False
With safety function Safe programmable logic	False
With safety function Safe Speed Monitor (SSM)	False
With safety function Safe Stop 1 (SS1)	False
With sft fct Safe Stop 2 (SS2)	False
With safety function Safe torque off (STO)	True
With safety function Safely Limited Position (SLP)	False
With safety function Safe Direction (SDI)	False
Protection type	Thermal protection: motor Safe torque off: motor Motor phase break: motor Thermal protection: drive Safe torque off: drive Overheating: drive Overcurrent between output phases and earth: drive Overload of output voltage: drive Short-circuit protection: drive Motor phase break: drive Overvoltages on the DC bus: drive Line supply overvoltage: drive Line supply undervoltage: drive Line supply phase loss: drive Overspeed: drive Break on the control circuit: drive
Quantity per set	1
Width	400 mm
Height	2150 mm
Depth	605 mm
Net weight	310 kg

Environment

Insulation resistance	> 1 MOhm 500 V DC for 1 minute to earth
Noise level	69 dB conforming to 86/188/EEC
Pollution degree	2 conforming to IEC 61800-5-1
Vibration resistance	1.5 mm peak to peak (f= 2...13 Hz) conforming to IEC 60068-2-6 1 gn (f= 13...200 Hz) conforming to IEC 60068-2-6
Shock resistance	15 gn for 11 ms conforming to IEC 60068-2-27
Relative humidity	5...95 % without condensation conforming to IEC 60068-2-3
Ambient air temperature for operation	-15...40 °C (without derating) 40...50 °C (with derating factor)
Operating altitude	<= 1000 m without derating 1000...4800 m with current derating 1 % per 100 m
Operating position	Vertical +/- 10 degree
Product certifications	ATEX EAC C-Tick
Marking	CE

Standards	IEC 60204-1 IEC 61800-2 IEC 61800-3 IEC 61800-5-1
Maximum THDI	<48 % full load conforming to IEC 61000-3-12
Electromagnetic compatibility	Electrostatic discharge immunity test level 3 conforming to IEC 61000-4-2 Radiated radio-frequency electromagnetic field immunity test level 3 conforming to IEC 61000-4-3 Electrical fast transient/burst immunity test level 4 conforming to IEC 61000-4-4 1.2/50 μ s - 8/20 μ s surge immunity test level 3 conforming to IEC 61000-4-5 Conducted radio-frequency immunity test level 3 conforming to IEC 61000-4-6
Environmental class (during operation)	Class 3C3 according to IEC 60721-3-3 Class 3S3 according to IEC 60721-3-3
Maximum acceleration under shock impact (during operation)	40 m/s ² at 11 ms
Maximum acceleration under vibrational stress (during operation)	6 m/s ² at 13...200 Hz
Maximum deflection under vibratory load (during operation)	1.5 mm at 2...13 Hz
Permitted relative humidity (during operation)	Class 3K5 according to EN 60721-3
Volume of cooling air	720 m ³ /h
Overvoltage category	III
Regulation loop	Adjustable PID regulator
Noise level	69 dB
Pollution degree	2
Ambient air transport temperature	-25...70 °C
Ambient air temperature for storage	-40...70 °C

Packing Units

Unit Type of Package 1	PCE
Number of Units in Package 1	1
Package 1 Height	258.0 cm
Package 1 Width	85.0 cm
Package 1 Length	75.0 cm
Package 1 Weight	350.0 kg

Contractual warranty

Warranty (in months)	18
-----------------------------	----



Environmental Data

Schneider Electric aims to achieve Net Zero status by 2050 through supply chain partnerships, lower impact materials, and circularity via our ongoing “Use Better, Use Longer, Use Again” campaign to extend product lifetimes and recyclability.

[Environmental Data explained >](#)

[How we assess product sustainability >](#)

Environmental footprint

Total lifecycle Carbon footprint 147633

Environmental Disclosure [Product Environmental Profile](#)

Use Better

Materials and Substances

Packaging made with recycled cardboard No

Packaging without single use plastic No

[EU RoHS Directive](#) Pro-active compliance (Product out of EU RoHS legal scope)

SCIP Number 3a1ae1b7-96ff-4a20-9804-40393f13630f

REACH Regulation [REACH Declaration](#)

Energy efficiency

Product contributes to saved and avoided emissions Yes

Use Longer

Lifetime extension

Repair No

Product repair index A

Use Again

Repack and remanufacture

End of life manual availability [End of Life Information](#)

Take-back No

Dimensions Drawings

Dimensions

Right and Front Views

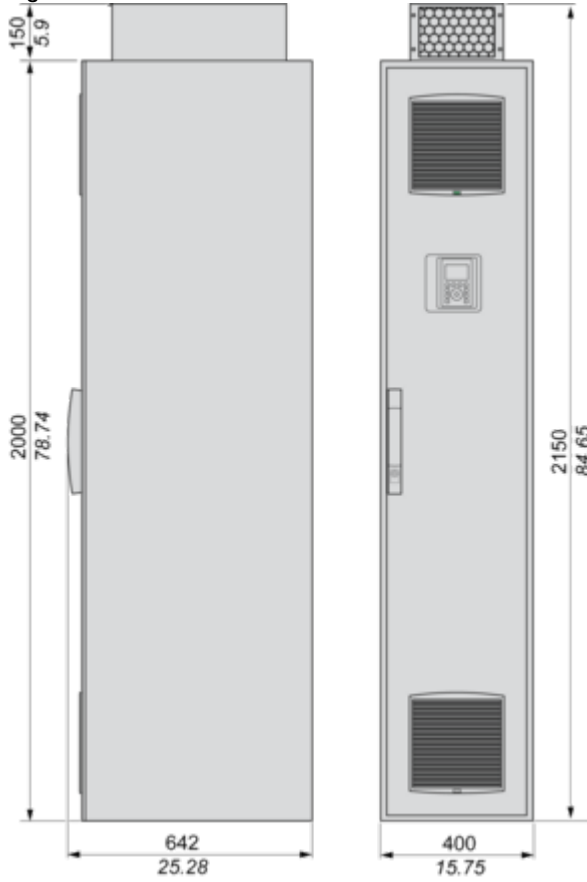

Mounting and Clearance

Clearances

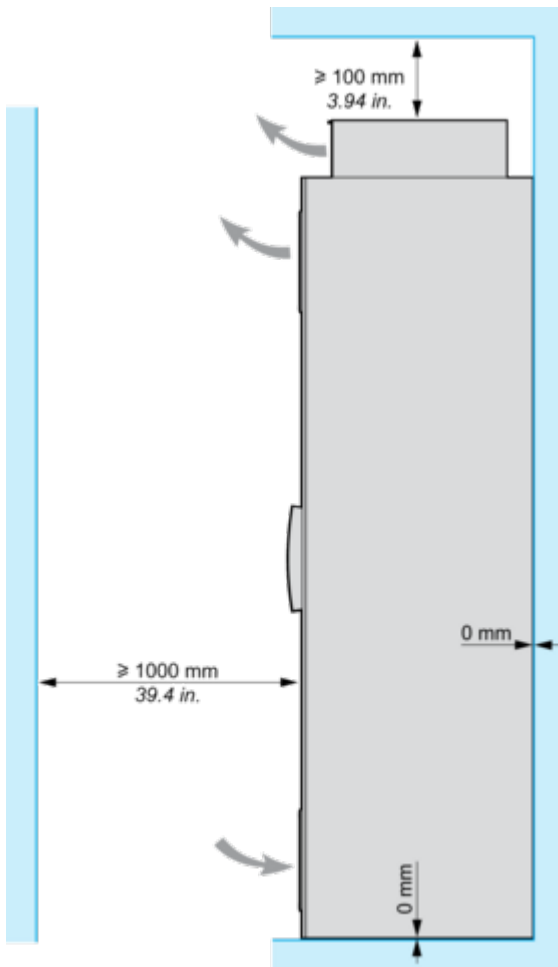

Connections and Schema

Floor Standing Drive Circuit Diagram

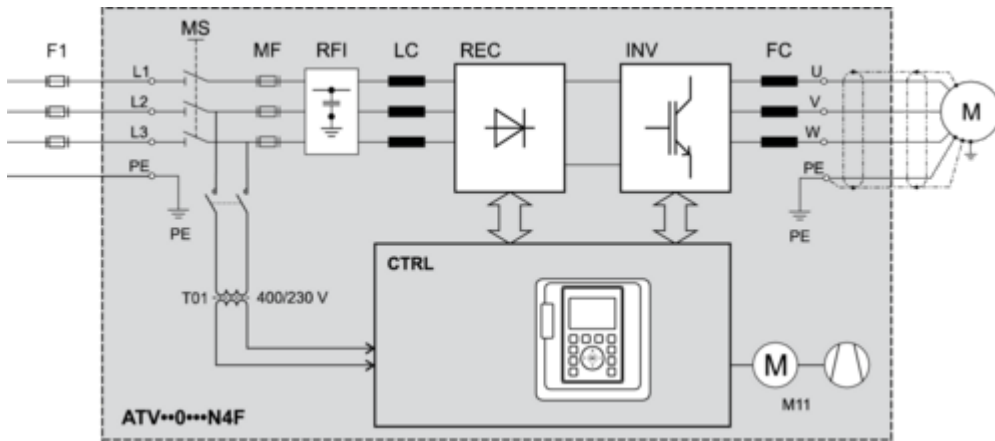

- F1** External pre-fuse or circuit breaker
- MS** Built-in main switch (only available on IP54 drives)
- T01** Control transformer 400 / 230 V AC
- MF** aR fuses
- RFI** Built-in RFI filter
- LC** Line reactor choke
- REC** Rectifier module
- INV** Inverter module
- FC** dv/dt filter (from 355 kW the dv/dt filter choke 150 m is built-in as standard)
- CTRL** Control panel
- M11** Fan in enclosure door

Control Block Wiring Diagram



- (1) Safe Torque Off
- (2) Analog Output
- (3) Digital Input
- (4) Reference potentiometer
- (5) Analog Input
- R1A, R1B, R1C : Fault relay
- R2A, R2C : Sequence relay
- R3A, R3C : Sequence relay

Sensor Connection

It is possible to connect either 1 or 3 sensors on terminals AI2 or AI3.

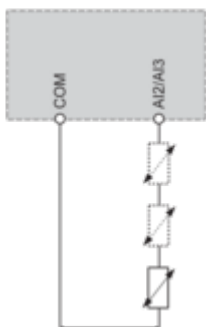

Sink / Source Switch Configuration

The switch is used to adapt the operation of the logic inputs to the technology of the programmable controller outputs.

- Set the switch to Source (factory setting) if using PLC outputs with PNP transistors.
- Set the switch to Ext if using PLC outputs with NPN transistors.

Switch Set to SRC (Source) Position Using the Output Power Supply for the Digital Inputs

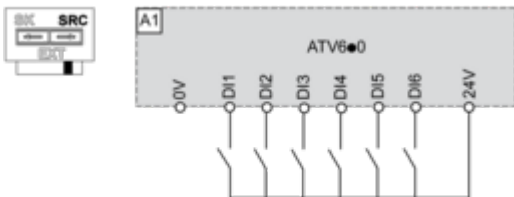

Switch Set to SRC (Source) Position and Use of an External Power Supply for the DIs

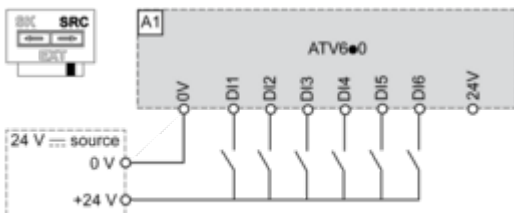

Switch Set to SK (Sink) Position Using the Output Power Supply for the Digital Inputs

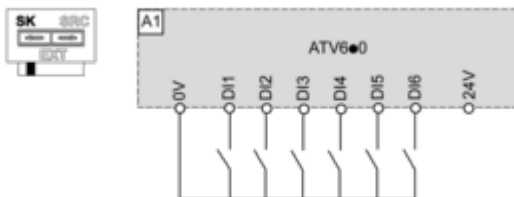

Switch Set to EXT Position Using an External Power Supply for the DIs

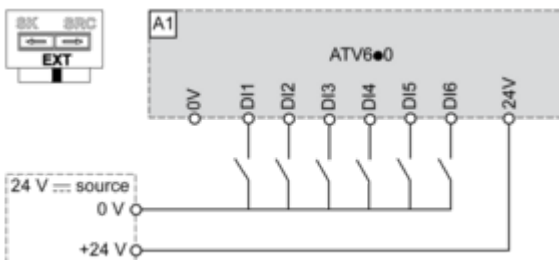

Performance Curves

Derating Curves

Normal Duty

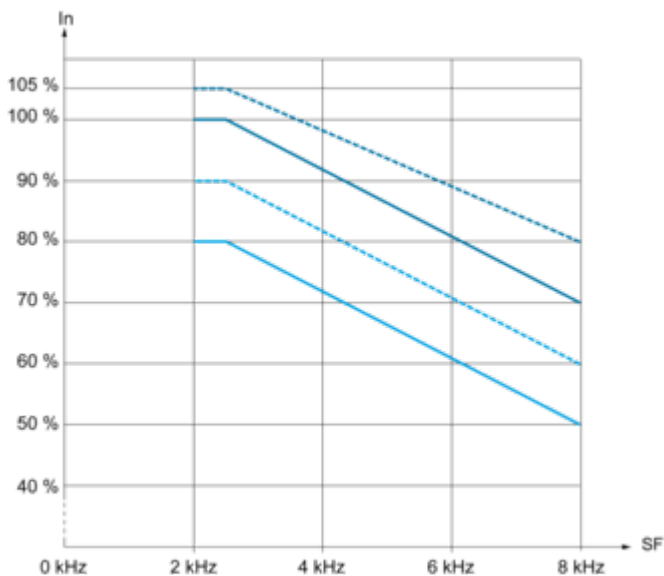

..... 30 °C (86 °F)
 ——— 40 °C (104 °F)
 - - - 45 °C (122 °F)
 ——— 50 °C (140 °F)
 In : Nominal Drive Current
 SF : Switching Frequency

Heavy Duty

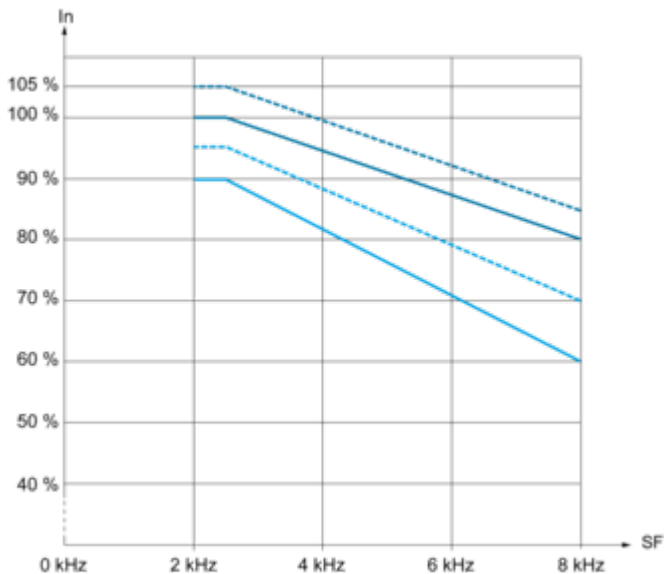

..... 30 °C (86 °F)
 ——— 40 °C (104 °F)
 - - - 45 °C (122 °F)
 ——— 50 °C (140 °F)
 In : Nominal Drive Current
 SF : Switching Frequency

Technical Illustration

Dimensions

