

Product datasheet

Specifications



Variable speed drive, Altivar Solar, 2.2kW, 200 to 240V, 1 phase, compact

ATV320U22M2C412

Price: 13,134.52 ZAR

Main

Range of product	Altivar Solar
Product or component type	Variable speed drive
Product specific application	Pumping applications
Variant	Standard version
Format of the drive	Compact
Mounting mode	Wall mount
Communication port protocol	Modbus serial CANopen
Option card	Communication module, Ethernet IP/Modbus TCP
[Us] rated supply voltage	200...240 V - 15...10 %
nominal output current	11.0 A
Motor power kW	2.2 kW for heavy duty
EMC filter	Class C2 EMC filter integrated
IP degree of protection	IP20

Complementary

Discrete input number	7
Discrete input type	STO safe torque off, 24 V DC, impedance: 1.5 kOhm DI1...DI6 logic inputs, 24 V DC (30 V) DI5 programmable as pulse input: 0...30 kHz, 24 V DC (30 V)
Discrete input logic	Positive logic (source) Negative logic (sink)
Discrete output number	3
Discrete output type	Open collector DQ+ 0...1 kHz 30 V DC 100 mA Open collector DQ- 0...1 kHz 30 V DC 100 mA
Analogue input number	3
Analogue input type	AI1 voltage: 0...10 V DC, impedance: 30 kOhm, resolution 10 bits AI2 bipolar differential voltage: +/- 10 V DC, impedance: 30 kOhm, resolution 10 bits AI3 current: 0...20 mA (or 4-20 mA, x-20 mA, 20-x mA or other patterns by configuration), impedance: 250 Ohm, resolution 10 bits
Analogue output number	1
Analogue output type	Software-configurable current AQ1: 0...20 mA impedance 800 Ohm, resolution 10 bits Software-configurable voltage AQ1: 0...10 V DC impedance 470 Ohm, resolution 10 bits
Relay output number	2

Excluding VAT and subject to change. Please check with your local distributor through "Where to buy"

Relay output type	Configurable relay logic R1A 1 NO electrical durability 100000 cycles Configurable relay logic R1B 1 NC electrical durability 100000 cycles Configurable relay logic R1C Configurable relay logic R2A 1 NO electrical durability 100000 cycles Configurable relay logic R2C
Maximum switching current	Relay output R1A, R1B, R1C on resistive load, cos phi = 1: 3 A at 250 V AC Relay output R1A, R1B, R1C on resistive load, cos phi = 1: 3 A at 30 V DC Relay output R1A, R1B, R1C, R2A, R2C on inductive load, cos phi = 0.4 and L/R = 7 ms: 2 A at 250 V AC Relay output R1A, R1B, R1C, R2A, R2C on inductive load, cos phi = 0.4 and L/R = 7 ms: 2 A at 30 V DC Relay output R2A, R2C on resistive load, cos phi = 1: 5 A at 250 V AC Relay output R2A, R2C on resistive load, cos phi = 1: 5 A at 30 V DC
Minimum switching current	Relay output R1A, R1B, R1C, R2A, R2C: 5 mA at 24 V DC
Method of access	Slave CANopen
Number of addresses	1...247 1...126
Data format	8 bits, configurable odd, even or no parity
Type of polarization	No impedance
4 quadrant operation possible	True
Asynchronous motor control profile	Voltage/frequency ratio, 5 points Flux vector control without sensor, standard Voltage/frequency ratio - Energy Saving, quadratic U/f Flux vector control without sensor - Energy Saving Voltage/frequency ratio, 2 points
Synchronous motor control profile	Vector control without sensor
Maximum output frequency	0.599 kHz
Acceleration and deceleration ramps	Linear U S CUS Ramp switching Acceleration/deceleration ramp adaptation Acceleration/deceleration automatic stop with DC injection Automatic adaptation of ramp if braking capacity exceeded, by using resistor Linear adjustable separately from 0.01 to 6000 s
Motor slip compensation	Automatic whatever the load Adjustable 0...300 % Not available in voltage/frequency ratio (2 or 5 points)
Switching frequency	2...16 kHz adjustable 4...16 kHz with derating factor
Nominal switching frequency	4 kHz
Braking to standstill	By DC injection
Brake chopper integrated	True
Line current	24.0 A at 200 V (heavy duty) 20.2 A at 240 V (heavy duty)
Maximum input current	24.0 A
Maximum output voltage	240 V
Apparent power	4.8 kVA at 240 V (heavy duty)
Maximum transient current	16.5 A during 60 s
Short-circuit protection	thermal protection
Network frequency	50...60 Hz
Relative symmetric network frequency tolerance	5 %
Prospective line I_{sc}	1 kA

Base load current at high overload	17.0 A
Power dissipation in W	Fan: 99.0 W at 200 V, switching frequency 4 kHz
Electrical connection	Screw terminal, clamping capacity: 0.5...1.5 mm ² for analog input Screw terminal for analog output Screw terminal
With safety function Safely Limited Speed (SLS)	True
With safety function Safe brake management (SBC/SBT)	False
With safety function Safe Operating Stop (SOS)	False
With safety function Safe Position (SP)	False
With safety function Safe programmable logic	False
With safety function Safe Speed Monitor (SSM)	False
With safety function Safe Stop 1 (SS1)	True
With sft fct Safe Stop 2 (SS2)	False
With safety function Safe torque off (STO)	True
With safety function Safely Limited Position (SLP)	False
With safety function Safe Direction (SDI)	False
Protection type	Input phase breaks: drive Overcurrent between output phases and earth: drive Overheating protection: drive Short-circuit between motor phases: drive Thermal protection: drive
Width	105.0 mm
Height	142.0 mm
Depth	158.0 mm
Net weight	1.6 kg
Power factor	0.616 at 230 V
Braking torque	170 % with braking resistor
Local signalling	1 LED (red) for drive fault 1 LED (red) for CANopen error 1 LED (green) for CANopen run
Transient overtorque	170...200 % of nominal motor torque

Environment

Operating position	Vertical +/- 10 degree
Product certifications	CE UR UKCA RCM
Marking	CE UR UKCA RCM
Standards	IEC 61800-5-1
Assembly style	With heat sink

Electromagnetic compatibility	Electrostatic discharge immunity test level 3 conforming to IEC 61000-4-2 Radiated radio-frequency electromagnetic field immunity test level 3 conforming to IEC 61000-4-3 Electrical fast transient/burst immunity test level 4 conforming to IEC 61000-4-4 1.2/50 μ s - 8/20 μ s surge immunity test level 3 conforming to IEC 61000-4-5 Conducted radio-frequency immunity test level 3 conforming to IEC 61000-4-6 Voltage dips and interruptions immunity test conforming to IEC 61000-4-11
Environmental class (during operation)	Class 3C3 according to IEC 60721-3-3 Class 3S2 according to IEC 60721-3-3
Maximum acceleration under shock impact (during operation)	150 m/s ² at 11 ms
Maximum acceleration under vibrational stress (during operation)	10 m/s ² at 13...200 Hz
Maximum deflection under vibratory load (during operation)	1.5 mm at 2...13 Hz
Permitted relative humidity (during operation)	Class 3K5 according to EN 60721-3
Volume of cooling air	16.0 m ³ /h
Overvoltage category	II
Regulation loop	Adjustable PID regulator
Speed accuracy	+/- 10 % of nominal slip 0.2 Tn to Tn
Noise level	48 dB
Pollution degree	2
Ambient air transport temperature	-25...70 °C
Ambient air temperature for operation	-10...50 °C without derating 50...60 °C with derating factor
Ambient air temperature for storage	-25...70 °C
Operating altitude	1000...2000 m with current derating 1 % per 100 m <= 1000 m without derating

Packing Units

Unit Type of Package 1	PCE
Number of Units in Package 1	1
Package 1 Height	18 cm
Package 1 Width	18.5 cm
Package 1 Length	18.5 cm
Package 1 Weight	1.899 kg
Unit Type of Package 2	S06
Number of Units in Package 2	30
Package 2 Height	75 cm
Package 2 Width	60 cm
Package 2 Length	80 cm
Package 2 Weight	69.97 kg

Contractual warranty

Warranty (in months)	18
-----------------------------	----



Environmental Data

Schneider Electric aims to achieve Net Zero status by 2050 through supply chain partnerships, lower impact materials, and circularity via our ongoing “Use Better, Use Longer, Use Again” campaign to extend product lifetimes and recyclability.

[Environmental Data explained >](#)

[How we assess product sustainability >](#)

Environmental footprint

Total lifecycle Carbon footprint 2065

Environmental Disclosure [Product Environmental Profile](#)

Use Better

Materials and Substances

Packaging made with recycled cardboard Yes

Packaging without single use plastic Yes

[EU RoHS Directive](#) Pro-active compliance (Product out of EU RoHS legal scope)

SCIP Number C0283eca-ae5-4ec9-9f8c-c7e056d0a8d7

REACH Regulation [REACH Declaration](#)

Use Longer

Lifetime extension

Repair No

Use Again

Repack and remanufacture

End of life manual availability [End of Life Information](#)

Take-back No

WEEE Label The product must be disposed on European Union markets following specific waste collection and never end up in rubbish bins

Dimensions Drawings

Dimensions

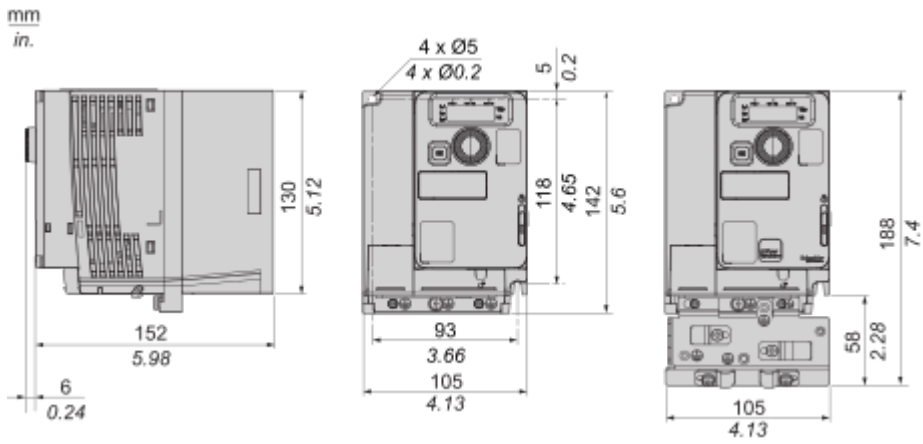

Mounting and Clearance

Mounting Types

Individual with Ventilation Cover

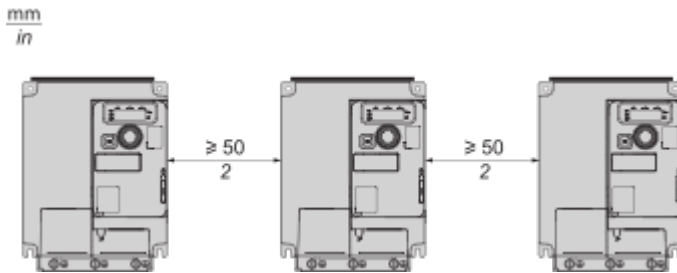

Free space ≥ 50 mm (2 in.) on each side, with vent cover fitted.
Mounting type A is suitable for drive operation at surrounding air temperature less or equal to 50 °C (122 °F)

Side by Side, Ventilation Cover Removed

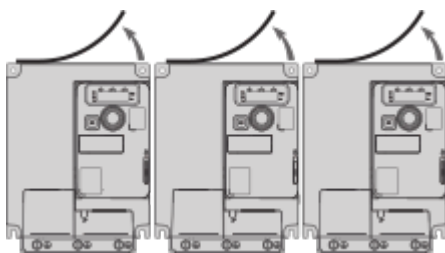

Drives mounted side-by-side, vent cover should be removed. The degree of protection becomes IP20.

Individual, Ventilation Cover Removed

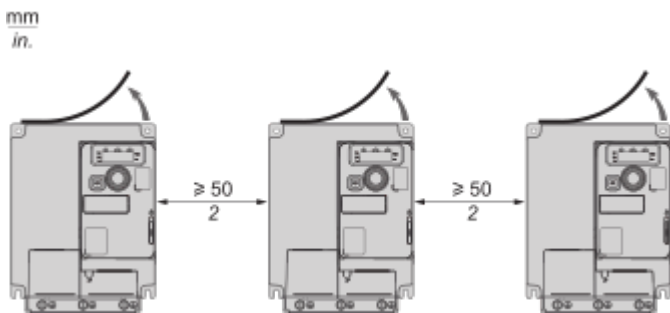

Free space ≥ 50 mm (2 in.) on each side. Vent cover should be removed for operation at surrounding air temperature above 50 °C (122 °F). The degree of protection becomes IP20.

Connections and Schema

Wiring

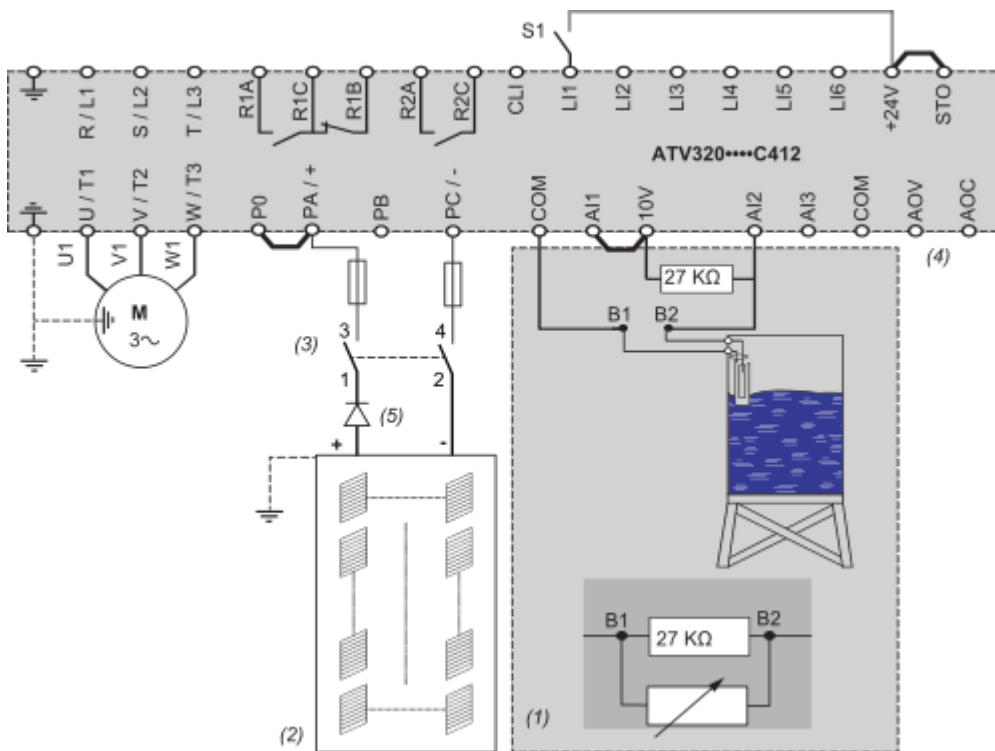

- (1) Tank water / liquid probe is optional.
- (2) The photovoltaic modules used shall comply with UL 1703. The solar panels and the drive input shall be in compliance with NEC article 690. For the photovoltaic installation ground connection, safety instructions and orientation, refer to the photovoltaic panel user manual.
- (3) Protection according to the concerned voltage, current and according to the photovoltaic arrays manual.
- (4) For AOC or AOV diagnostic values on ATV320 Solar drive.
- (5) On some applications, a blocking diode is mandatory.

NOTE: Check that the Logic Input switch is on Source position:



Performance Curves

Derating Curves

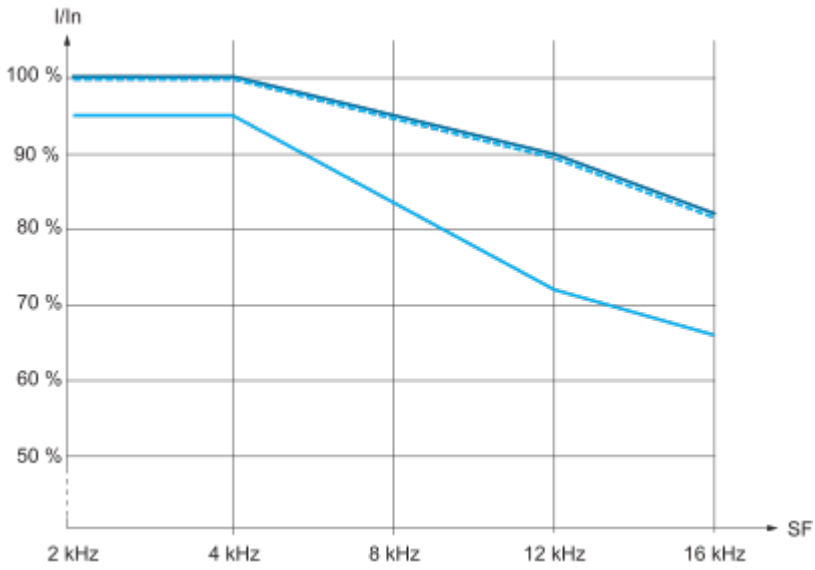

- 40 °C (104 °F) - Mounting type A, B and C
 - ⋯ 50 °C (122 °F) - Mounting type C
 - 60 °C (140 °F) - Mounting type C
- In** : Nominal Drive Current
SF : Switching Frequency

Technical Illustration

Dimensions

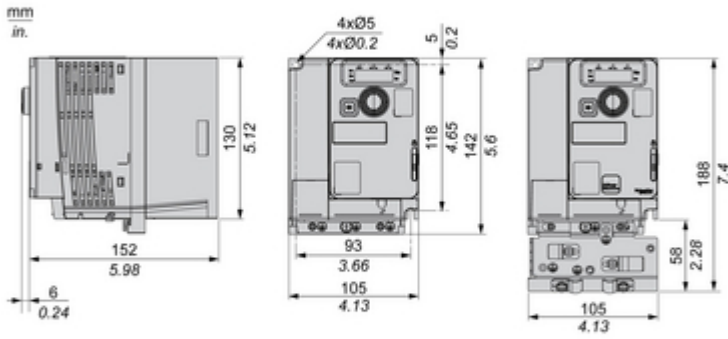

Image of product / Alternate images

Alternative





