

# Product datasheet

Specifications



Variable speed drive. Altivar  
Process ATV600. ATV650. 132 kW.  
400...480 V. floor standing

ATV650C13N4F

**Price: 417,600.76 ZAR**

## Main

Range of product	Altivar Process ATV600
Product specific application	Process and utilities
Product or component type	Variable speed drive
Variant	With disconnect switch
Device short name	ATV650
Mounting mode	Floor-standing
Communication port protocol	Modbus serial Ethernet Ethernet
[Us] rated supply voltage	380...440 V - 15...10 %
[Us] rated supply voltage	380...440 V
Relative symmetric mains voltage tolerance	10 %
Relative symmetric network frequency tolerance	5 %
nominal output current	250.0 A
IP degree of protection	IP54
Product destination	Asynchronous motors Synchronous motors
EMC filter	Integrated with 150 m conforming to IEC 61800-3 category C3
IP degree of protection	IP54 conforming to IEC 60529 IP54 conforming to IEC 61800-5-1
Type of cooling	Forced convection
Supply frequency	50...60 Hz - 5...5 %
Motor power kW	132 kW (normal duty) 110 kW (heavy duty)
Line current	210 A at 400 V (heavy duty) 179 A at 380 V (normal duty) 244 A at 380 V (heavy duty) 207 A at 400 V (normal duty)
Continuous output current	250 A at 2.5 kHz for normal duty 211 A at 2.5 kHz for heavy duty
Speed drive output frequency	0.1...500 Hz
Safety function	STO (safe torque off) SIL 3

Excluding VAT and subject to change. Please check with your local distributor through "Where to buy"

<b>Option card</b>	Slot A: communication module, PROFINET Slot A: communication module, DeviceNet Slot A: communication module, Modbus TCP/EtherNet/IP Slot A: communication module, CANopen daisy chain RJ45 Slot A: communication module, CANopen SUB-D 9 Slot A: communication module, CANopen screw terminals Slot A/slot B: digital and analog I/O extension module Slot A/slot B: output relay extension module Slot A: communication module, Ethernet IP/Modbus TCP/MD-Link Communication module, BACnet MS/TP Communication module, Ethernet Powerlink Slot A: communication module, Profibus DP V1
--------------------	---

## Complementary

<b>Discrete input number</b>	8
<b>Discrete input type</b>	DI7, DI8 programmable as pulse input: 0...30 kHz, 24 V DC (<= 30 V)
<b>Discrete input logic</b>	16 preset speeds
<b>Discrete output number</b>	0
<b>Discrete output type</b>	Relay outputs R1A, R1B, R1C 250 V AC 3000 mA Relay outputs R1A, R1B, R1C 30 V DC 3000 mA Relay outputs R2A, R2C 250 V AC 5000 mA Relay outputs R2A, R2C 30 V DC 5000 mA Relay outputs R3A, R3C 250 V AC 5000 mA Relay outputs R3A, R3C 30 V DC 5000 mA
<b>Analogue input number</b>	3
<b>Analogue input type</b>	AI1, AI2, AI3 software-configurable voltage: 0...10 V DC, impedance: 31.5 kOhm, resolution 12 bits AI1, AI2, AI3 software-configurable current: 0...20 mA, impedance: 250 Ohm, resolution 12 bits AI2 voltage analog input: - 10...10 V DC, impedance: 31.5 kOhm, resolution 12 bits
<b>Analogue output number</b>	2
<b>Analogue output type</b>	Software-configurable voltage AQ1, AQ2: 0...10 V DC impedance 470 Ohm, resolution 10 bits Software-configurable current AQ1, AQ2: 0...20 mA, resolution 10 bits Software-configurable current DQ-, DQ+: 30 V DC Software-configurable current DQ-, DQ+: 100 mA
<b>Relay output number</b>	3
<b>Relay output type</b>	Configurable relay logic R2: sequence relay NO electrical durability 100000 cycles Configurable relay logic R3: sequence relay NO electrical durability 100000 cycles Configurable relay logic R1: fault relay NO/NC electrical durability 100000 cycles
<b>Maximum switching current</b>	Relay output R1, R2, R3 on resistive load, cos phi = 1: 3 A at 30 V DC Relay output R1, R2, R3 on inductive load, cos phi = 0.4 and L/R = 7 ms: 2 A at 250 V AC Relay output R1, R2, R3 on inductive load, cos phi = 0.4 and L/R = 7 ms: 2 A at 30 V DC Relay output R1, R2, R3 on resistive load, cos phi = 1: 3 A at 250 V AC
<b>Minimum switching current</b>	Relay output R1, R2, R3: 5 mA at 24 V DC
<b>Network number of phases</b>	3 phases
<b>Physical interface</b>	Ethernet 2-wire RS 485
<b>Method of access</b>	Slave Modbus TCP
<b>Transmission rate</b>	10, 100 Mbits 4800 bps, 9600 bps, 19200 bps, 38.4 Kbps
<b>Transmission frame</b>	RTU
<b>Output voltage</b>	<= power supply voltage
<b>Permissible temporary current boost</b>	1.5 x I <sub>n</sub> during 60 s (heavy duty) 1.1 x I <sub>n</sub> during 60 s (normal duty)
<b>Data format</b>	8 bits, configurable odd, even or no parity

<b>Type of polarization</b>	No impedance
<b>Frequency resolution</b>	Analog input: 0.012/50 Hz Display unit: 0.1 Hz
<b>Electrical connection</b>	Line side: M12 bar - 1 cables 3 x 150 mm <sup>2</sup> minimum per phase (normal duty) Line side: M12 bar - 2 cables 3 x 70 mm <sup>2</sup> minimum per phase (normal duty) Line side: M12 bar - 1 cables 3 x 185 mm <sup>2</sup> maximum per phase (normal duty) Line side: M12 bar - 2 cables 3 x 120 mm <sup>2</sup> maximum per phase (normal duty) Motor: M12 bar - 1 cables 3 x 120 mm <sup>2</sup> minimum per phase (normal duty) Motor: M12 bar - 2 cables 3 x 50 mm <sup>2</sup> minimum per phase (normal duty) Motor: M12 bar - 2 cables 3 x 185 mm <sup>2</sup> maximum per phase (normal duty) Line side: M12 bar - 1 cables 3 x 150 mm <sup>2</sup> minimum per phase (heavy duty) Line side: M12 bar - 2 cables 3 x 70 mm <sup>2</sup> minimum per phase (heavy duty) Line side: M12 bar - 1 cables 3 x 185 mm <sup>2</sup> maximum per phase (heavy duty) Line side: M12 bar - 2 cables 3 x 120 mm <sup>2</sup> maximum per phase (heavy duty) Motor: M12 bar - 1 cables 3 x 95 mm <sup>2</sup> minimum per phase (heavy duty) Motor: M12 bar - 2 cables 3 x 185 mm <sup>2</sup> maximum per phase (heavy duty) Control: removable screw terminals 0.5...1.5 mm <sup>2</sup>
<b>Connector type</b>	RJ45 (on the remote graphic terminal) for Modbus serial RJ45 (on the remote graphic terminal) for Ethernet/Modbus TCP
<b>Exchange mode</b>	Half duplex, full duplex, autonegotiation Ethernet/Modbus TCP
<b>Number of addresses</b>	1...247 for Modbus serial
<b>Supply</b>	Internal supply for reference potentiometer (1 to 10 kOhm): 10.5 V DC +/- 5 %, <10 mA, protection type: overload and short-circuit protection Internal supply for digital inputs and STO: 24 V DC (21...27 V), <200 mA, protection type: overload and short-circuit protection External supply for digital inputs: 24 V DC (19...30 V), <1.25 mA, protection type: overload and short-circuit protection
<b>Local signalling</b>	3 LEDs (dual colour) for embedded communication status 4 LEDs (dual colour) for communication module status 1 LED (red) for presence of voltage 3 LEDs for local diagnostic
<b>Input compatibility</b>	DI5, DI6: discrete input level 1 PLC conforming to IEC 65A-68 STOA, STOB: discrete input level 1 PLC conforming to IEC 61131-2 DI1...DI6: discrete input level 1 PLC conforming to IEC 61131-2
<b>Discrete input logic</b>	Positive logic (source) (DI1...DI8), < 5 V (state 0), > 11 V (state 1) Negative logic (sink) (DI1...DI8), > 16 V (state 0), < 10 V (state 1)
<b>Sampling duration</b>	5 ms +/- 1 ms (DI5, DI6) - discrete input 5 ms +/- 0.1 ms (AI1, AI2, AI3) - analog input 10 ms +/- 1 ms (AO1) - analog output 2 ms +/- 0.5 ms (DI1...DI4) - discrete input
<b>Accuracy</b>	+/- 1 % AO1, AO2 for a temperature variation 60 °C analog output +/- 0.6 % AI1, AI2, AI3 for a temperature variation 60 °C analog input
<b>Linearity error</b>	AO1, AO2: +/- 0.2 % for analog output AI1, AI2, AI3: +/- 0.15 % of maximum value for analog input
<b>Refresh time</b>	Relay output (R1, R2, R3): 5 ms (+/- 0.5 ms)
<b>Isolation</b>	Between power and control terminals

<b>Discrete and process manufacturing</b>	Food and beverage processing other application Mining mineral and metal fan Mining mineral and metal pump Oil and gas fan Water and waste water other application Building - HVAC screw compressor Food and beverage processing pump Food and beverage processing fan Food and beverage processing atomization Oil and gas electro submersible pump (ESP) Oil and gas water injection pump Oil and gas jet fuel pump Oil and gas compressor for refinery Water and waste water centrifuge pump Water and waste water positive displacement pump Water and waste water electro submersible pump (ESP) Water and waste water screw pump Water and waste water lobe compressor Water and waste water screw compressor Water and waste water compressor centrifugal Water and waste water fan Water and waste water conveyer Water and waste water mixer Building - HVAC compressor centrifugal
<b>Power range</b>	110...220 kW at 480...500 V 3 phases 110...220 kW at 380...440 V 3 phases
<b>Enclosure mounting</b>	Floor-standing
<b>4 quadrant operation possible</b>	False
<b>Asynchronous motor control profile</b>	Constant torque standard Optimized torque mode Variable torque standard
<b>Synchronous motor control profile</b>	Synchronous reluctance motor Permanent magnet motor
<b>Maximum output frequency</b>	500 kHz
<b>Acceleration and deceleration ramps</b>	Linear adjustable separately from 0.01...9999 s
<b>Motor slip compensation</b>	Adjustable Can be suppressed Not available in permanent magnet motor law Automatic whatever the load
<b>Switching frequency</b>	2...8 kHz adjustable 2.5...8 kHz with derating factor
<b>Nominal switching frequency</b>	2.5 kHz
<b>Braking to standstill</b>	By DC injection
<b>Brake chopper integrated</b>	False
<b>Maximum input current</b>	244.0 A
<b>Maximum output voltage</b>	440.0 V
<b>Apparent power</b>	160 kVA at 440 V (normal duty) 136 kVA at 440 V (heavy duty)
<b>Maximum transient current</b>	275 A during 60 s (normal duty) 317 A during 60 s (heavy duty)
<b>Network frequency</b>	50...60 Hz
<b>Prospective line I<sub>sc</sub></b>	50 kA
<b>Base load current at high overload</b>	211.0 A
<b>Base load current at low overload</b>	250.0 A
<b>Power dissipation in W</b>	2010 W, switching frequency 2.5 kHz (heavy duty) 3150 W, switching frequency 2.5 kHz (normal duty)
<b>With safety function Safely Limited Speed (SLS)</b>	False

With safety function Safe brake management (SBC/SBT)	False
With safety function Safe Operating Stop (SOS)	False
With safety function Safe Position (SP)	False
With safety function Safe programmable logic	False
With safety function Safe Speed Monitor (SSM)	False
With safety function Safe Stop 1 (SS1)	False
With sft fct Safe Stop 2 (SS2)	False
With safety function Safe torque off (STO)	True
With safety function Safely Limited Position (SLP)	False
With safety function Safe Direction (SDI)	False
Protection type	Safe torque off: motor Motor phase break: motor Thermal protection: drive Safe torque off: drive Overheating: drive Overcurrent between output phases and earth: drive Overload of output voltage: drive Short-circuit protection: drive Motor phase break: drive Overvoltages on the DC bus: drive Line supply overvoltage: drive Line supply undervoltage: drive Line supply phase loss: drive Overspeed: drive Break on the control circuit: drive Thermal protection: motor
Quantity per set	1
Width	400 mm
Height	2350 mm
Depth	669 mm
Net weight	330 kg

## Environment

Insulation resistance	> 1 MOhm 500 V DC for 1 minute to earth
Noise level	69 dB conforming to 86/188/EEC
Pollution degree	2 conforming to IEC 61800-5-1
Vibration resistance	1 gn (f= 13...200 Hz) conforming to IEC 60068-2-6 1.5 mm peak to peak (f= 2...13 Hz) conforming to IEC 60068-2-6
Shock resistance	15 gn for 11 ms conforming to IEC 60068-2-27
Relative humidity	5...95 % without condensation conforming to IEC 60068-2-3
Ambient air temperature for operation	40...50 °C (with derating factor) -15...40 °C (without derating)
Operating altitude	1000...4800 m with current derating 1 % per 100 m <= 1000 m without derating
Operating position	Vertical +/- 10 degree
Product certifications	ATEX EAC C-Tick
Marking	CE

<b>Standards</b>	IEC 60204-1 IEC 61800-2 IEC 61800-3 IEC 61800-5-1
<b>Maximum THDI</b>	<48 % full load conforming to IEC 61000-3-12
<b>Electromagnetic compatibility</b>	Radiated radio-frequency electromagnetic field immunity test level 3 conforming to IEC 61000-4-3 Electrical fast transient/burst immunity test level 4 conforming to IEC 61000-4-4 1.2/50 $\mu$ s - 8/20 $\mu$ s surge immunity test level 3 conforming to IEC 61000-4-5 Conducted radio-frequency immunity test level 3 conforming to IEC 61000-4-6 Electrostatic discharge immunity test level 3 conforming to IEC 61000-4-2
<b>Environmental class (during operation)</b>	Class 3C3 according to IEC 60721-3-3 Class 3S3 according to IEC 60721-3-3
<b>Maximum acceleration under shock impact (during operation)</b>	40 m/s <sup>2</sup> at 11 ms
<b>Maximum acceleration under vibrational stress (during operation)</b>	6 m/s <sup>2</sup> at 13...200 Hz
<b>Maximum deflection under vibratory load (during operation)</b>	1.5 mm at 2...13 Hz
<b>Permitted relative humidity (during operation)</b>	Class 3K5 according to EN 60721-3
<b>Volume of cooling air</b>	720 m <sup>3</sup> /h
<b>Overvoltage category</b>	III
<b>Regulation loop</b>	Adjustable PID regulator
<b>Noise level</b>	69 dB
<b>Pollution degree</b>	3
<b>Ambient air transport temperature</b>	-25...70 °C
<b>Ambient air temperature for storage</b>	-40...70 °C

## Packing Units

<b>Unit Type of Package 1</b>	PCE
<b>Number of Units in Package 1</b>	1
<b>Package 1 Height</b>	80.000 cm
<b>Package 1 Width</b>	83.000 cm
<b>Package 1 Length</b>	222.000 cm
<b>Package 1 Weight</b>	380.000 kg

## Contractual warranty

<b>Warranty (in months)</b>	18
-----------------------------	----



## Environmental Data

Schneider Electric aims to achieve Net Zero status by 2050 through supply chain partnerships, lower impact materials, and circularity via our ongoing “Use Better, Use Longer, Use Again” campaign to extend product lifetimes and recyclability.

[Environmental Data explained >](#)

[How we assess product sustainability >](#)

### Environmental footprint

Total lifecycle Carbon footprint 114504

Environmental Disclosure [Product Environmental Profile](#)

## Use Better

### Materials and Substances

Packaging made with recycled cardboard No

Packaging without single use plastic No

[EU RoHS Directive](#)

Pro-active compliance (Product out of EU RoHS legal scope)

SCIP Number

D85bea05-cdd1-41b2-b42a-71d8bf09d77f

REACH Regulation

[REACH Declaration](#)

### Energy efficiency

Product contributes to saved and avoided emissions Yes

## Use Longer

### Lifetime extension

Repair No

Product repair index A

## Use Again

### Repack and remanufacture

End of life manual availability [End of Life Information](#)

Take-back No

Dimensions Drawings

Dimensions

---

Right and Front Views

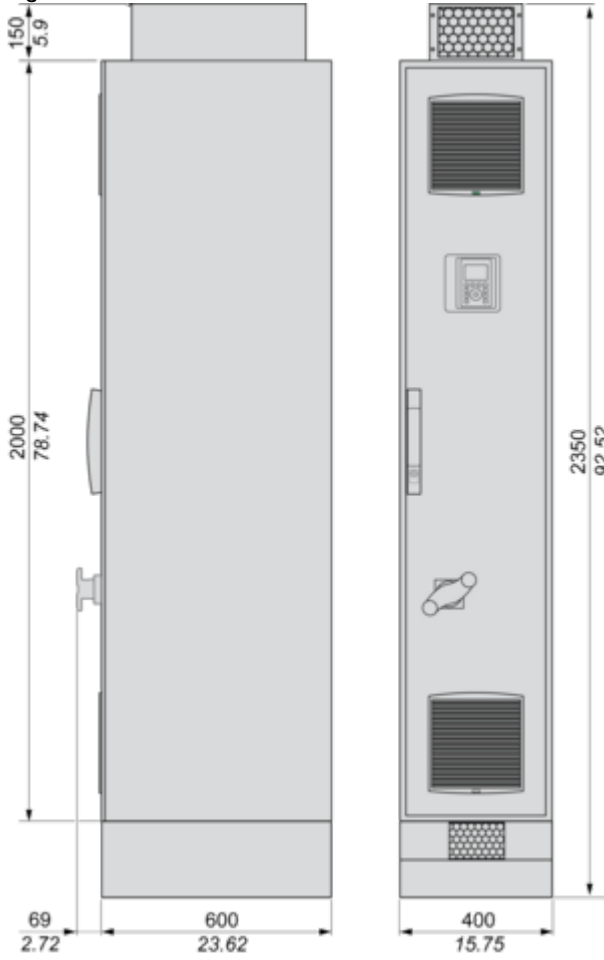

Mounting and Clearance

Clearances

---

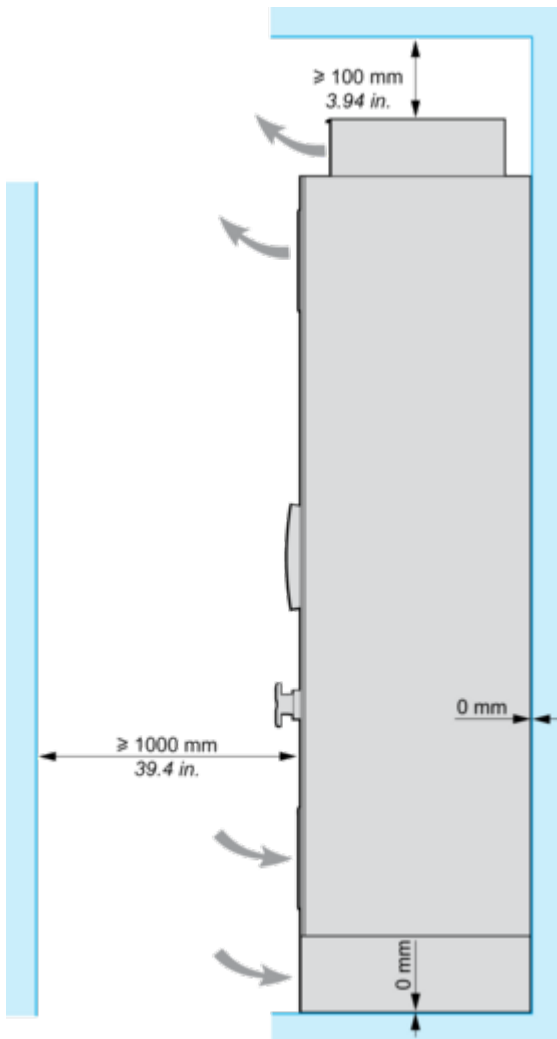

Connections and Schema

Floor Standing Drive Circuit Diagram

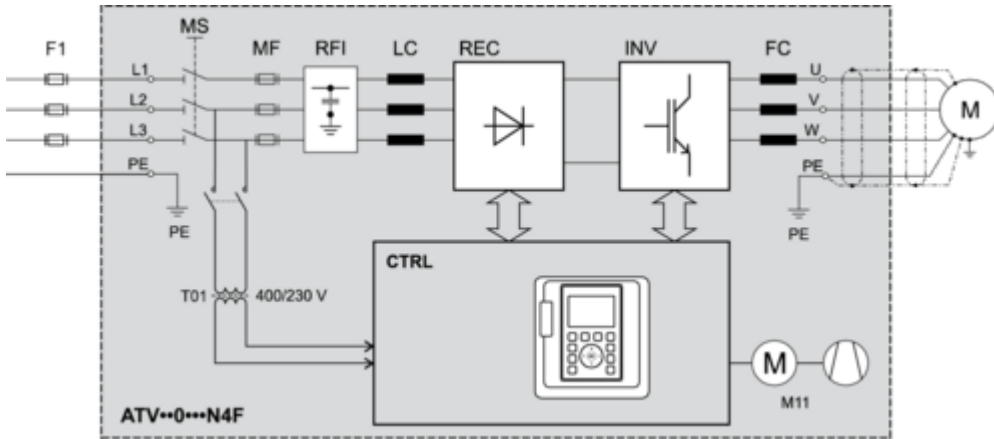

- F1** External pre-fuse or circuit breaker
- MS** Built-in main switch (only available on IP54 drives)
- T01** Control transformer 400 / 230 V AC
- MF** aR fuses
- RFI** Built-in RFI filter
- LC** Line reactor choke
- REC** Rectifier module
- INV** Inverter module
- FC** dv/dt filter (from 355 kW the dv/dt filter choke 150 m is built-in as standard)
- CTRL** Control panel
- M11** Fan in enclosure door

Control Block Wiring Diagram



- (1) Safe Torque Off
- (2) Analog Output
- (3) Digital Input
- (4) Reference potentiometer
- (5) Analog Input
- (6) Analog Input
- R1A, R1B, R1C : Fault relay
- R2A, R2C : Sequence relay
- R3A, R3C : Sequence relay

Sensor Connection

It is possible to connect either 1 or 3 sensors on terminals AI2 or AI3.

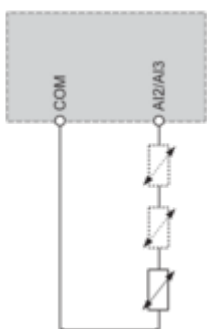

**Sink / Source Switch Configuration**

The switch is used to adapt the operation of the logic inputs to the technology of the programmable controller outputs.

- Set the switch to Source (factory setting) if using PLC outputs with PNP transistors.
- Set the switch to Ext if using PLC outputs with NPN transistors.

**Switch Set to SRC (Source) Position Using the Output Power Supply for the Digital Inputs**

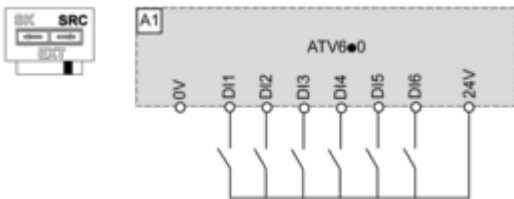

**Switch Set to SRC (Source) Position and Use of an External Power Supply for the DIs**

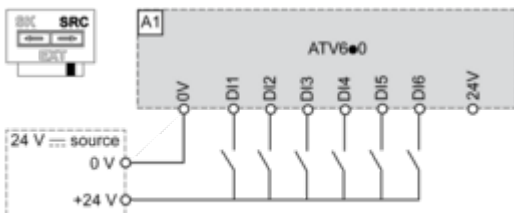

**Switch Set to SK (Sink) Position Using the Output Power Supply for the Digital Inputs**

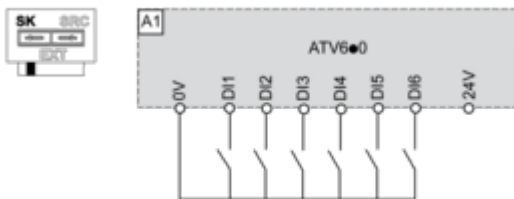

**Switch Set to EXT Position Using an External Power Supply for the DIs**

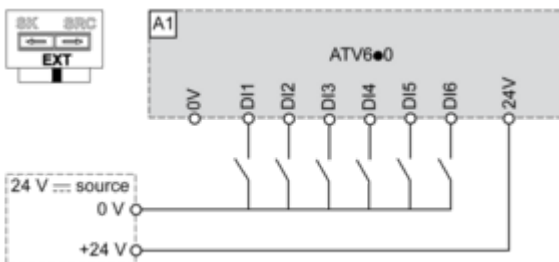

Performance Curves

Derating Curves

Normal Duty

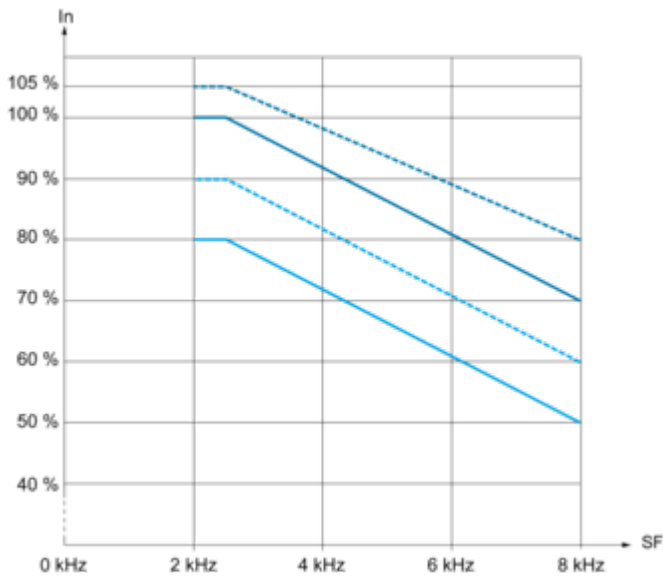

- 30 °C (86 °F)
- 40 °C (104 °F)
- 45 °C (122 °F)
- 50 °C (140 °F)

In : Nominal Drive Current  
 SF : Switching Frequency

Heavy Duty

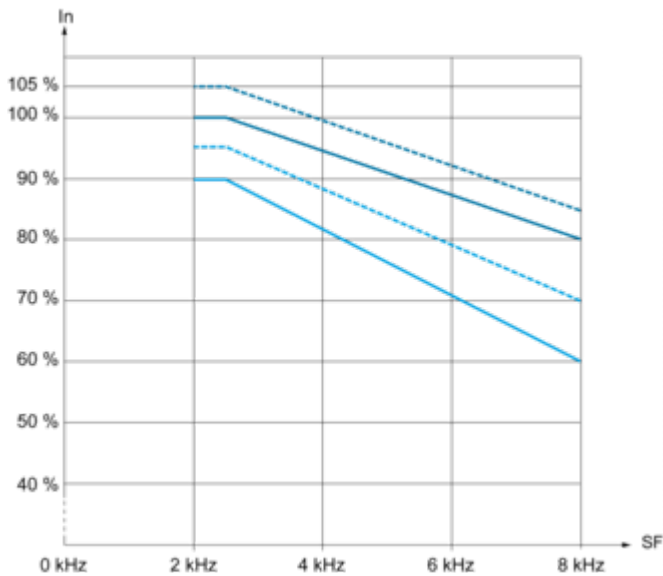

- 30 °C (86 °F)
- 40 °C (104 °F)
- 45 °C (122 °F)
- 50 °C (140 °F)

In : Nominal Drive Current  
 SF : Switching Frequency



Technical Illustration

Dimensions

---

