

# Product datasheet

Specifications



## variable speed drive ATV212 - 75kW - 100hp - 480V - 3ph - EMC class C2 - IP55

ATV212WD75N4

**Price: 208,198.42 ZAR**

### Main

Device short name	ATV212
Product destination	Asynchronous motors
Network number of phases	3 phases
Motor power kW	75 kW
Motor power hp	100 hp
Supply voltage limits	323...528 V
Supply frequency	50...60 Hz - 5...5 %
Line current	141.8 A at 380 V 111.3 A at 480 V
Range of product	Altivar 212
Product or component type	Variable speed drive
Product specific application	Pumps and fans in HVAC
Communication port protocol	BACnet METASYS N2 Modbus LonWorks APOGEE FLN
[Us] rated supply voltage	380...480 V - 15...10 %
EMC filter	Class C2 EMC filter integrated
IP degree of protection	IP55

### Complementary

Apparent power	105.3 kVA at 380 V
Continuous output current	160 A at 380 V 160 A at 460 V
Maximum transient current	176 A for 60 s
Speed drive output frequency	0.5...200 Hz
Speed range	1...10
Speed accuracy	+/- 10 % of nominal slip 0.2 Tn to Tn
Local signalling	1 LED (red) for DC bus energized
Output voltage	<= power supply voltage
Isolation	Electrical between power and control
Type of cable	Without mounting kit: 1 wire(s)IEC cable at 45 °C, copper 90 °C / XLPE/EPR Without mounting kit: 1 wire(s)IEC cable at 45 °C, copper 70 °C / PVC With UL Type 1 kit: 3 wire(s)UL 508 cable at 40 °C, copper 75 °C / PVC

Excluding VAT and subject to change. Please check with your local distributor through "Where to buy"

<b>Electrical connection</b>	VIA, VIB, FM, FLA, FLB, FLC, RY, RC, F, R, RES: terminal 2.5 mm <sup>2</sup> / AWG 14 L1/R, L2/S, L3/T: terminal 150 mm <sup>2</sup> (300 kcmil)
<b>Tightening torque</b>	0.6 N.m (VIA, VIB, FM, FLA, FLB, FLC, RY, RC, F, R, RES) 41 N.m, 360 lb.in (L1/R, L2/S, L3/T)
<b>Supply</b>	Internal supply for reference potentiometer (1 to 10 kOhm): 10.5 V DC +/- 5 %, <10 A, protection type: overload and short-circuit protection Internal supply: 24 V DC (21...27 V), <200 A, protection type: overload and short-circuit protection
<b>Sampling duration</b>	2 ms +/- 0.5 ms F discrete 2 ms +/- 0.5 ms R discrete 2 ms +/- 0.5 ms RES discrete 3.5 ms +/- 0.5 ms VIA analog 22 ms +/- 0.5 ms VIB analog
<b>Response time</b>	FM 2 ms, tolerance +/- 0.5 ms for analog output(s) FLA, FLC 7 ms, tolerance +/- 0.5 ms for discrete output(s) FLB, FLC 7 ms, tolerance +/- 0.5 ms for discrete output(s) RY, RC 7 ms, tolerance +/- 0.5 ms for discrete output(s)
<b>Accuracy</b>	+/- 0.6 % (VIA) for a temperature variation 60 °C +/- 0.6 % (VIB) for a temperature variation 60 °C +/- 1 % (FM) for a temperature variation 60 °C
<b>Linearity error</b>	VIA: +/- 0.15 % of maximum value for input VIB: +/- 0.15 % of maximum value for input FM: +/- 0.2 % for output
<b>Analogue output type</b>	FM switch-configurable voltage 0...10 V DC, impedance: 7620 Ohm, resolution 10 bits FM switch-configurable current 0...20 mA, impedance: 970 Ohm, resolution 10 bits
<b>Discrete output type</b>	Configurable relay logic: (FLA, FLC) NO - 100000 cycles Configurable relay logic: (FLB, FLC) NC - 100000 cycles Configurable relay logic: (RY, RC) NO - 100000 cycles
<b>Minimum switching current</b>	3 mA at 24 V DC for configurable relay logic
<b>Maximum switching current</b>	5 A at 250 V AC on resistive load - cos phi = 1 - L/R = 0 ms (FL, R) 5 A at 30 V DC on resistive load - cos phi = 1 - L/R = 0 ms (FL, R) 2 A at 250 V AC on inductive load - cos phi = 0.4 - L/R = 7 ms (FL, R) 2 A at 30 V DC on inductive load - cos phi = 0.4 - L/R = 7 ms (FL, R)
<b>Discrete input type</b>	F programmable 24 V DC, with level 1 PLC, impedance: 4700 Ohm R programmable 24 V DC, with level 1 PLC, impedance: 4700 Ohm RES programmable 24 V DC, with level 1 PLC, impedance: 4700 Ohm
<b>Discrete input logic</b>	Positive logic (source) (F, R, RES), <= 5 V (state 0), >= 11 V (state 1) Negative logic (sink) (F, R, RES), >= 16 V (state 0), <= 10 V (state 1)
<b>Dielectric strength</b>	3535 V DC between earth and power terminals 5092 V DC between control and power terminals
<b>Insulation resistance</b>	>= 1 mOhm 500 V DC for 1 minute
<b>Frequency resolution</b>	Display unit: 0.1 Hz Analog input: 0.024/50 Hz
<b>Communication service</b>	Write single register (06) Time out setting from 0.1 to 100 s Read device identification (43) Write multiple registers (16) 2 words maximum Monitoring inhibitible Read holding registers (03) 2 words maximum
<b>Option card</b>	Communication card for LonWorks
<b>Functionality</b>	Mid
<b>Specific application</b>	HVAC
<b>Discrete output number</b>	2
<b>Analogue input number</b>	2

<b>Analogue input type</b>	VIA switch-configurable voltage: 0...10 V DC 24 V max, impedance: 30000 Ohm, resolution 10 bits VIB configurable voltage: 0...10 V DC 24 V max, impedance: 30000 Ohm, resolution 10 bits VIB configurable PTC probe: 0...6 probes, impedance: 1500 Ohm VIA switch-configurable current: 0...20 mA, impedance: 250 Ohm, resolution 10 bits
<b>Analogue output number</b>	1
<b>Physical interface</b>	2-wire RS 485
<b>Connector type</b>	1 RJ45 1 open style
<b>Transmission rate</b>	9600 bps or 19200 bps
<b>Transmission frame</b>	RTU
<b>Number of addresses</b>	1...247
<b>Data format</b>	8 bits, 1 stop, odd even or no configurable parity
<b>Type of polarization</b>	No impedance
<b>Asynchronous motor control profile</b>	Voltage/frequency ratio - Energy Saving, quadratic U/f Flux vector control without sensor, standard Voltage/frequency ratio, 5 points Voltage/frequency ratio, 2 points Voltage/frequency ratio, automatic IR compensation (U/f + automatic U <sub>0</sub> )
<b>Torque accuracy</b>	+/- 15 %
<b>Transient overtorque</b>	120 % of nominal motor torque +/- 10 % for 60 s
<b>Acceleration and deceleration ramps</b>	Linear adjustable separately from 0.01 to 3200 s Automatic based on the load
<b>Motor slip compensation</b>	Adjustable Not available in voltage/frequency ratio motor control Automatic whatever the load
<b>Switching frequency</b>	6...16 kHz adjustable 8...16 kHz with derating factor
<b>Nominal switching frequency</b>	8 kHz
<b>Braking to standstill</b>	By DC injection
<b>Network frequency</b>	47.5...63 Hz
<b>Prospective line I<sub>sc</sub></b>	22 kA
<b>Protection type</b>	Overheating protection: drive Thermal power stage: drive Short-circuit between motor phases: drive Input phase breaks: drive Overcurrent between output phases and earth: drive Overvoltages on the DC bus: drive Break on the control circuit: drive Against exceeding limit speed: drive Line supply overvoltage and undervoltage: drive Line supply undervoltage: drive Against input phase loss: drive Thermal protection: motor Motor phase break: motor With PTC probes: motor
<b>Width</b>	362 mm
<b>Height</b>	1000 mm
<b>Depth</b>	364 mm

## Environment

<b>Pollution degree</b>	3 conforming to IEC 61800-5-1
<b>IP degree of protection</b>	IP55 conforming to IEC 61800-5-1 IP55 conforming to IEC 60529

<b>Vibration resistance</b>	1.5 mm (f= 3...13 Hz) conforming to IEC 60068-2-6 1 gn (f= 13...200 Hz) conforming to EN/IEC 60068-2-8
<b>Shock resistance</b>	15 gn for 11 ms conforming to IEC 60068-2-27
<b>Environmental characteristic</b>	Classes 3C1 conforming to IEC 60721-3-3 Classes 3S2 conforming to IEC 60721-3-3
<b>Noise level</b>	63.7 dB conforming to 86/188/EEC
<b>Operating altitude</b>	1000...3000 m limited to 2000 m for the Corner Grounded distribution network with current derating 1 % per 100 m <= 1000 m without derating
<b>Relative humidity</b>	5...95 % without condensation conforming to IEC 60068-2-3 5...95 % without dripping water conforming to IEC 60068-2-3
<b>Ambient air temperature for operation</b>	-10...40 °C (without derating) 40...50 °C (with derating factor)
<b>Operating position</b>	Vertical +/- 10 degree
<b>Product certifications</b>	UL NOM 117 CSA C-Tick
<b>Marking</b>	CE
<b>Standards</b>	IEC 61800-3 environments 2 category C2 IEC 61800-3 environments 2 category C3 IEC 61800-3 category C2 IEC 61800-3 category C3 IEC 61800-3 environments 1 category C2 IEC 61800-3 IEC 61800-5-1 IEC 61800-3 environments 1 category C3 IEC 61800-3 environments 2 category C3 EN 61800-3 category C3 IEC 61800-3 environments 1 category C2 IEC 61800-5-1 IEC 61800-3 environments 1 category C1 IEC 61800-3 environments 2 category C1 EN 55011 class A group 1 IEC 61800-3 IEC 61800-3 category C2 IEC 61800-3 environments 2 category C1 IEC 61800-3 environments 1 category C3 IEC 61800-3 environments 1 category C1 IEC 61800-3 environments 2 category C2
<b>Assembly style</b>	With heat sink
<b>Electromagnetic compatibility</b>	Electrostatic discharge immunity test level 3 conforming to IEC 61000-4-2 Radiated radio-frequency electromagnetic field immunity test level 3 conforming to IEC 61000-4-3 Electrical fast transient/burst immunity test level 4 conforming to IEC 61000-4-4 1.2/50 µs - 8/20 µs surge immunity test level 3 conforming to IEC 61000-4-5 Conducted radio-frequency immunity test level 3 conforming to IEC 61000-4-6 Voltage dips and interruptions immunity test conforming to IEC 61000-4-11
<b>Regulation loop</b>	Adjustable PI regulator
<b>Ambient air temperature for storage</b>	-25...70 °C

## Packing Units

<b>Unit Type of Package 1</b>	PCE
<b>Number of Units in Package 1</b>	1
<b>Package 1 Height</b>	60.0 cm
<b>Package 1 Width</b>	47.0 cm
<b>Package 1 Length</b>	116.0 cm
<b>Package 1 Weight</b>	36.0 kg

# Contractual warranty

---

Warranty (in months)

18



## Environmental Data

Schneider Electric aims to achieve Net Zero status by 2050 through supply chain partnerships, lower impact materials, and circularity via our ongoing “Use Better, Use Longer, Use Again” campaign to extend product lifetimes and recyclability.

[Environmental Data explained >](#)

[How we assess product sustainability >](#)



### Environmental footprint

[Environmental Disclosure](#)

[Product Environmental Profile](#)

## Use Better



### Materials and Substances

Packaging made with recycled cardboard

No

Packaging without single use plastic

Yes

[EU RoHS Directive](#)

Pro-active compliance (Product out of EU RoHS legal scope)

SCIP Number

91c5351a-f7de-4fe3-98f9-eeb2cc54ad0d

REACH Regulation

[REACH Declaration](#)



### Energy efficiency

Product contributes to saved and avoided emissions

Yes

## Use Longer



### Lifetime extension

Repair

No

## Use Again



### Repack and remanufacture

End of life manual availability

[End of Life Information](#)

Take-back

No

WEEE Label

 The product must be disposed on European Union markets following specific waste collection and never end up in rubbish bins

Dimensions Drawings

Dimensions

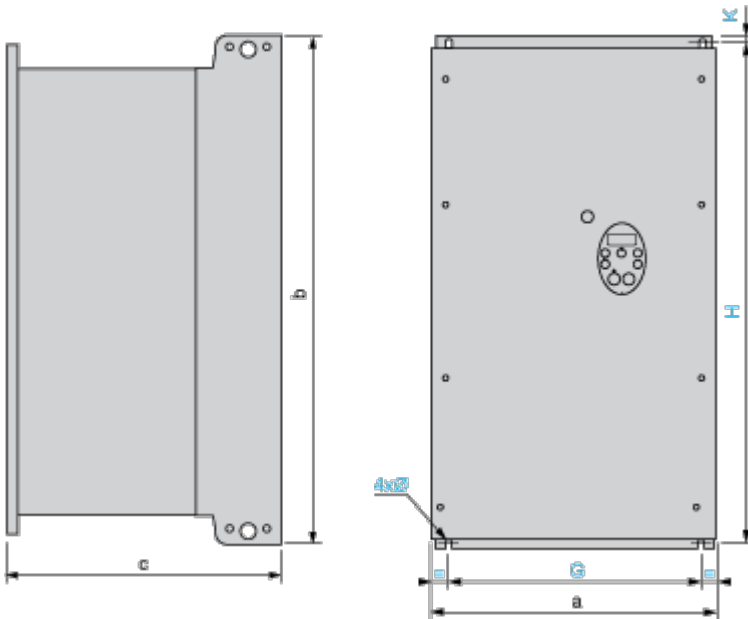

Dimensions in mm

ATV212W	a	b	c	G	H	K	ø
D11N4, D15N4 D11N4C, D15N4C	290	560	315	250	544	8	6
D18N4 D18N4C	310	665	315	270	650	10	6
D22N4, D30N4 D22N4C, D30N4C	284	720	315	245	700	10	7
D37N4, D45N4 D37N4C, D45N4C	284	880	343	245	860	10	7
D55N4, D75N4 D55N4C, D75N4C	362	1000	364	300	975	10	9

Dimensions in in.

ATV212W	a	b	c	G	H	K	ø
D11N4, D15N4 D11N4C, D15N4C	11.42	22.05	12.40	9.84	21.42	0.31	0.24
D18N4 D18N4C	12.20	26.18	12.40	10.63	25.59	0.39	0.24
D22N4, D30N4 D22N4C, D30N4C	11.18	28.35	12.40	9.65	27.56	0.39	0.27
D37N4, D45N4 D37N4C, D45N4C	11.18	34.65	13.50	9.65	33.86	0.39	0.27
D55N4, D75N4 D55N4C, D75N4C	14.25	39.37	14.33	11.81	38.39	0.39	0.35



Mounting and Clearance

Mounting Recommendations

---

Clearance

Depending on the conditions in which the drive is to be used, its installation will require certain precautions and the use of appropriate accessories.

Install the unit vertically:

- Do not place it close to heating elements.
- Leave sufficient free space to ensure that the air required for cooling purposes can circulate from bottom to the top of the unit.

Type A Mounting

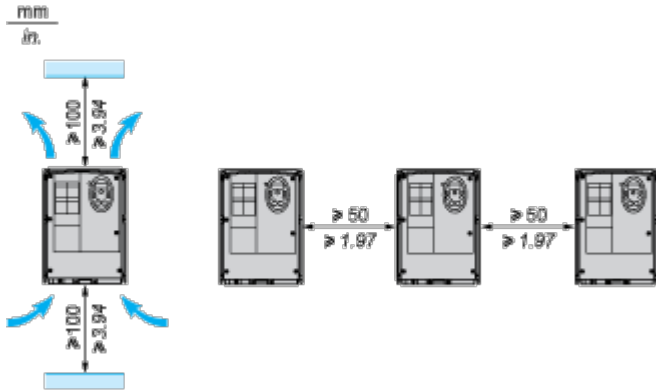

Connections and Schema

Recommended Wiring Diagram

3-Phase Power Supply

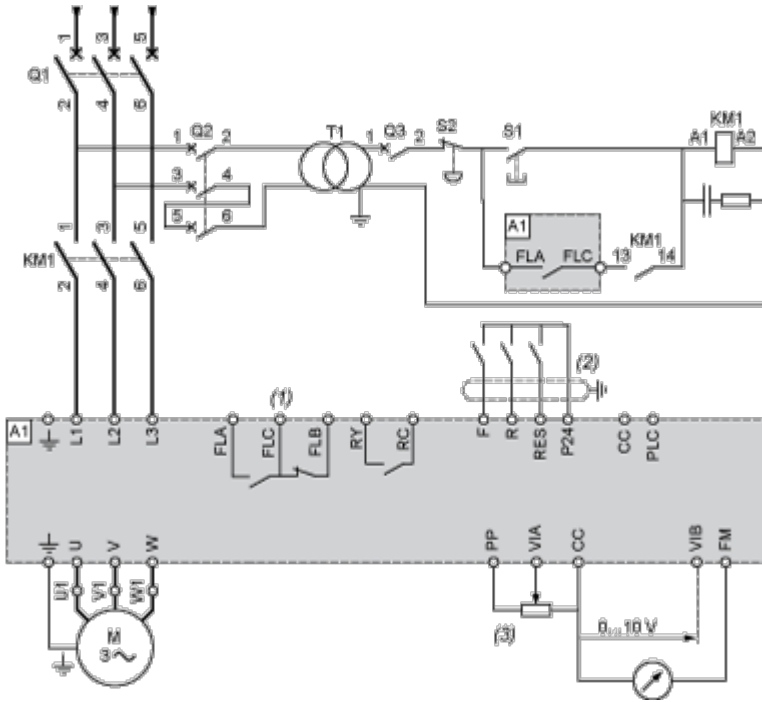

A1: ATV 212 drive

KM1: Contactor

Q1: Circuit breaker

Q2: GV2 L rated at twice the nominal primary current of T1

Q3: GB2CB05

S1, S2: XB4 B or XB5 A pushbuttons

T1: 100 VA transformer 220 V secondary

(1) Fault relay contacts for remote signalling of the drive status

(2) Connection of the common for the logic inputs depends on the positioning of the switch (Source, PLC, Sink)

(3) Reference potentiometer SZ1RV1202

**NOTE:** All terminals are located at the bottom of the drive. Install interference suppressors on all inductive circuits near the drive or connected on the same circuit, such as relays, contactors, solenoid valves, fluorescent lighting, etc.

Switches (Factory Settings)

Voltage/current selection for analog I/O (VIA and VIB)



Voltage/current selection for analog I/O (FM)



Selection of logic type

PLC

Sink (1)    Source (2)

(1) negative logic

(2) positive logic

Other Possible Wiring Diagrams

Logic Inputs According to the Position of the Logic Type Switch

“Source” position

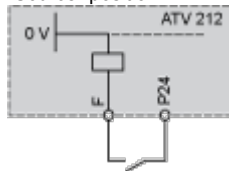

“Sink” position

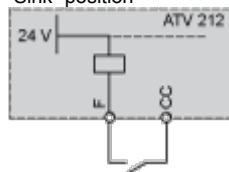

“PLC” position with PLC transistor outputs

<p>(1) PLC</p>	<p>(1) PLC</p>
----------------	----------------

2-wire control

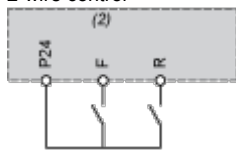

F: Forward

R: Preset speed

(2) ATV 212 control terminals

3-wire control

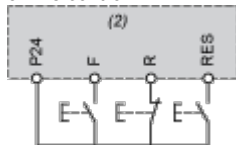

F: Forward

R: Stop

RES: Reverse

(2) ATV 212 control terminals

PTC probe

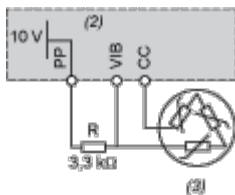

- (2) ATV 212 control terminals
- (3) Motor

**Analog Inputs**

Voltage analog inputs

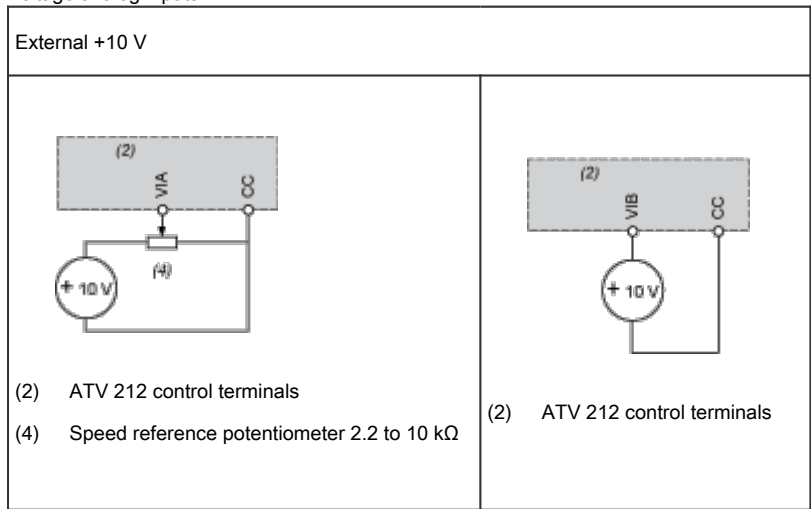

Analog input configured for current: 0-20 mA, 4-20 mA, X-Y mA

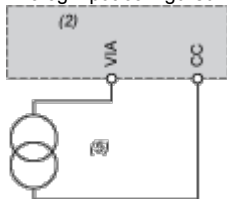

- (2) ATV 212 control terminals
- (5) Source 0-20 mA, 4-20 mA, X-Y mA

Analog input VIA configured as positive logic input ("Source" position)

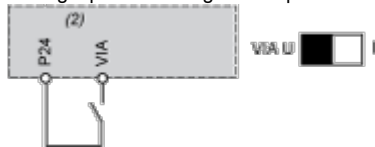

- (2) ATV 212 control terminals

Analog input VIA configured as negative logic input ("Sink" position)

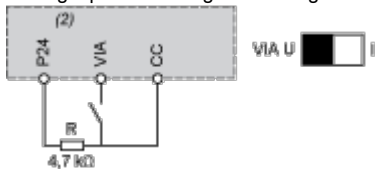

- (2) ATV 212 control terminals

Performance Curves

Derating Curves

---

The derating curves for the drive nominal current ( $I_n$ ) depend on the temperature and the switching frequency. For intermediate temperatures (45°C for example), interpolate between 2 curves.

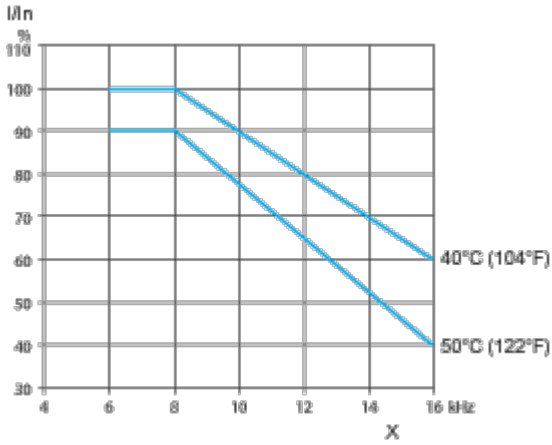

X Switching frequency