

Product datasheet

Specifications



ATV212HD45N4 - Variable speed drive ATV212 - 45kW - 60hp - 480V - 3ph - EMC - IP21

ATV212HD45N4

Price: 100,013.00 ZAR

Main

Device short name	ATV212
Product destination	Asynchronous motors
Network number of phases	3 phases
Motor power kW	45 kW
Motor power hp	60 hp
Supply voltage limits	323...528 V
Supply frequency	50...60 Hz - 5...5 %
Line current	83.8 A at 380 V 65.9 A at 480 V
Range of product	Altivar 212
Product or component type	Variable speed drive
Product specific application	Pumps and fans in HVAC
Communication port protocol	Modbus LonWorks METASYS N2 BACnet APOGEE FLN
[Us] rated supply voltage	380...480 V - 15...10 %
EMC filter	Class C2 EMC filter integrated
IP degree of protection	IP21

Complementary

Apparent power	61.9 kVA at 380 V
Continuous output current	94 A at 380 V 94 A at 460 V
Maximum transient current	103.4 A for 60 s
Speed drive output frequency	0.5...200 Hz
Speed range	1...10
Speed accuracy	+/- 10 % of nominal slip 0.2 Tn to Tn
Local signalling	1 LED (red) for DC bus energized
Output voltage	<= power supply voltage
Isolation	Electrical between power and control
Type of cable	Without mounting kit: 1 wire(s)IEC cable at 45 °C, copper 90 °C / XLPE/EPR Without mounting kit: 1 wire(s)IEC cable at 45 °C, copper 70 °C / PVC With UL Type 1 kit: 3 wire(s)UL 508 cable at 40 °C, copper 75 °C / PVC

Excluding VAT and subject to change. Please check with your local distributor through "Where to buy"

Electrical connection	VIA, VIB, FM, FLA, FLB, FLC, RY, RC, F, R, RES: terminal 2.5 mm ² / AWG 14 L1/R, L2/S, L3/T: terminal 50 mm ² / AWG 1/0
Tightening torque	0.6 N.m (VIA, VIB, FM, FLA, FLB, FLC, RY, RC, F, R, RES) 24 N.m, 212 lb.in (L1/R, L2/S, L3/T)
Supply	Internal supply for reference potentiometer (1 to 10 kOhm): 10.5 V DC +/- 5 %, <10 A, protection type: overload and short-circuit protection Internal supply: 24 V DC (21...27 V), <200 A, protection type: overload and short-circuit protection
Sampling duration	2 ms +/- 0.5 ms F discrete 2 ms +/- 0.5 ms R discrete 2 ms +/- 0.5 ms RES discrete 3.5 ms +/- 0.5 ms VIA analog 22 ms +/- 0.5 ms VIB analog
Response time	FM 2 ms, tolerance +/- 0.5 ms for analog output(s) FLA, FLC 7 ms, tolerance +/- 0.5 ms for discrete output(s) FLB, FLC 7 ms, tolerance +/- 0.5 ms for discrete output(s) RY, RC 7 ms, tolerance +/- 0.5 ms for discrete output(s)
Accuracy	+/- 0.6 % (VIA) for a temperature variation 60 °C +/- 0.6 % (VIB) for a temperature variation 60 °C +/- 1 % (FM) for a temperature variation 60 °C
Linearity error	VIA: +/- 0.15 % of maximum value for input VIB: +/- 0.15 % of maximum value for input FM: +/- 0.2 % for output
Analogue output type	FM switch-configurable voltage 0...10 V DC, impedance: 7620 Ohm, resolution 10 bits FM switch-configurable current 0...20 mA, impedance: 970 Ohm, resolution 10 bits
Discrete output type	Configurable relay logic: (FLA, FLC) NO - 100000 cycles Configurable relay logic: (FLB, FLC) NC - 100000 cycles Configurable relay logic: (RY, RC) NO - 100000 cycles
Minimum switching current	3 mA at 24 V DC for configurable relay logic
Maximum switching current	5 A at 250 V AC on resistive load - cos phi = 1 - L/R = 0 ms (FL, R) 5 A at 30 V DC on resistive load - cos phi = 1 - L/R = 0 ms (FL, R) 2 A at 250 V AC on inductive load - cos phi = 0.4 - L/R = 7 ms (FL, R) 2 A at 30 V DC on inductive load - cos phi = 0.4 - L/R = 7 ms (FL, R)
Discrete input type	F programmable 24 V DC, with level 1 PLC, impedance: 4700 Ohm R programmable 24 V DC, with level 1 PLC, impedance: 4700 Ohm RES programmable 24 V DC, with level 1 PLC, impedance: 4700 Ohm
Discrete input logic	Positive logic (source) (F, R, RES), <= 5 V (state 0), >= 11 V (state 1) Negative logic (sink) (F, R, RES), >= 16 V (state 0), <= 10 V (state 1)
Dielectric strength	3535 V DC between earth and power terminals 5092 V DC between control and power terminals
Insulation resistance	>= 1 mOhm 500 V DC for 1 minute
Frequency resolution	Display unit: 0.1 Hz Analog input: 0.024/50 Hz
Communication service	Read device identification (43) Write multiple registers (16) 2 words maximum Time out setting from 0.1 to 100 s Read holding registers (03) 2 words maximum Monitoring inhibitible Write single register (06)
Option card	Communication card for LonWorks
Power dissipation in W	1253 W
Air flow	429 m3/h
Functionality	Mid
Specific application	HVAC
Variable speed drive application selection	Building - HVAC compressor for scroll Building - HVAC fan Building - HVAC pump

Motor power range AC-3	30...50 kW at 380...440 V 3 phases 30...50 kW at 480...500 V 3 phases
Motor starter type	Variable speed drive
Discrete output number	2
Analogue input number	2
Analogue input type	VIA switch-configurable voltage: 0...10 V DC 24 V max, impedance: 30000 Ohm, resolution 10 bits VIB configurable voltage: 0...10 V DC 24 V max, impedance: 30000 Ohm, resolution 10 bits VIB configurable PTC probe: 0...6 probes, impedance: 1500 Ohm VIA switch-configurable current: 0...20 mA, impedance: 250 Ohm, resolution 10 bits
Analogue output number	1
Physical interface	2-wire RS 485
Connector type	1 RJ45 1 open style
Transmission rate	9600 bps or 19200 bps
Transmission frame	RTU
Number of addresses	1...247
Data format	8 bits, 1 stop, odd even or no configurable parity
Type of polarization	No impedance
Asynchronous motor control profile	Voltage/frequency ratio, automatic IR compensation (U/f + automatic U ₀) Voltage/frequency ratio - Energy Saving, quadratic U/f Voltage/frequency ratio, 2 points Voltage/frequency ratio, 5 points Flux vector control without sensor, standard
Torque accuracy	+/- 15 %
Transient overtorque	120 % of nominal motor torque +/- 10 % for 60 s
Acceleration and deceleration ramps	Linear adjustable separately from 0.01 to 3200 s Automatic based on the load
Motor slip compensation	Adjustable Not available in voltage/frequency ratio motor control Automatic whatever the load
Switching frequency	6...16 kHz adjustable 8...16 kHz with derating factor
Nominal switching frequency	8 kHz
Braking to standstill	By DC injection
Network frequency	47.5...63 Hz
Prospective line I_{sc}	22 kA
Protection type	Overheating protection: drive Thermal power stage: drive Short-circuit between motor phases: drive Input phase breaks: drive Overcurrent between output phases and earth: drive Overvoltages on the DC bus: drive Break on the control circuit: drive Against exceeding limit speed: drive Line supply overvoltage and undervoltage: drive Line supply undervoltage: drive Against input phase loss: drive Thermal protection: motor Motor phase break: motor With PTC probes: motor
Width	240 mm
Height	550 mm

Depth	244 mm
-------	--------

Environment

Pollution degree	3 conforming to IEC 61800-5-1
IP degree of protection	IP20 on upper part without blanking plate on cover conforming to IEC 61800-5-1 IP20 on upper part without blanking plate on cover conforming to IEC 60529 IP21 conforming to IEC 61800-5-1 IP21 conforming to IEC 60529 IP41 on upper part conforming to IEC 61800-5-1 IP41 on upper part conforming to IEC 60529
Vibration resistance	1.5 mm (f= 3...13 Hz) conforming to IEC 60068-2-6 1 gn (f= 13...200 Hz) conforming to EN/IEC 60068-2-8
Shock resistance	15 gn for 11 ms conforming to IEC 60068-2-27
Environmental characteristic	Classes 3C1 conforming to IEC 60721-3-3 Classes 3S2 conforming to IEC 60721-3-3
Noise level	64 dB conforming to 86/188/EEC
Operating altitude	1000...3000 m limited to 2000 m for the Corner Grounded distribution network with current derating 1 % per 100 m <= 1000 m without derating
Relative humidity	5...95 % without condensation conforming to IEC 60068-2-3 5...95 % without dripping water conforming to IEC 60068-2-3
Ambient air temperature for operation	-10...40 °C (without derating) 40...50 °C (with derating factor)
Operating position	Vertical +/- 10 degree
Product certifications	UL CSA NOM 117 C-Tick
Marking	CE
Standards	IEC 61800-3 IEC 61800-3 environments 1 category C3 IEC 61800-3 environments 1 category C1 IEC 61800-3 environments 1 category C3 EN 61800-3 category C3 IEC 61800-3 environments 2 category C3 EN 55011 class A group 1 IEC 61800-5-1 IEC 61800-3 environments 2 category C1 IEC 61800-5-1 IEC 61800-3 environments 2 category C3 IEC 61800-3 category C2 IEC 61800-3 category C2 IEC 61800-3 environments 1 category C2 IEC 61800-3 environments 1 category C2 IEC 61800-3 environments 2 category C2 IEC 61800-3 IEC 61800-3 environments 1 category C1 IEC 61800-3 environments 2 category C1 IEC 61800-3 environments 2 category C2 IEC 61800-3 category C3 UL Type 1
Assembly style	With heat sink
Electromagnetic compatibility	Electrostatic discharge immunity test level 3 conforming to IEC 61000-4-2 Radiated radio-frequency electromagnetic field immunity test level 3 conforming to IEC 61000-4-3 Electrical fast transient/burst immunity test level 4 conforming to IEC 61000-4-4 1.2/50 µs - 8/20 µs surge immunity test level 3 conforming to IEC 61000-4-5 Conducted radio-frequency immunity test level 3 conforming to IEC 61000-4-6 Voltage dips and interruptions immunity test conforming to IEC 61000-4-11
Regulation loop	Adjustable PI regulator
Ambient air temperature for storage	-25...70 °C

Packing Units

Unit Type of Package 1	PCE
Number of Units in Package 1	1
Package 1 Height	38.5 cm
Package 1 Width	45 cm
Package 1 Length	70 cm
Package 1 Weight	22.5 kg

Contractual warranty

Warranty (in months)	18
----------------------	----



Environmental Data

Schneider Electric aims to achieve Net Zero status by 2050 through supply chain partnerships, lower impact materials, and circularity via our ongoing “Use Better, Use Longer, Use Again” campaign to extend product lifetimes and recyclability.

[Environmental Data explained >](#)

[How we assess product sustainability >](#)



Environmental footprint

Environmental Disclosure

[Product Environmental Profile](#)

Use Better



Materials and Substances

Packaging made with recycled cardboard

Yes

Packaging without single use plastic

Yes

[EU RoHS Directive](#)

Pro-active compliance (Product out of EU RoHS legal scope)

SCIP Number

B2cadac9-e4c3-4178-afa8-06179c3cbbe7

REACH Regulation

[REACH Declaration](#)



Energy efficiency

Product contributes to saved and avoided emissions

Yes

Use Longer



Lifetime extension

Repair

No

Use Again



Repack and remanufacture

End of life manual availability

[End of Life Information](#)

Take-back

No

WEEE Label

 The product must be disposed on European Union markets following specific waste collection and never end up in rubbish bins

Dimensions Drawings

Dimensions

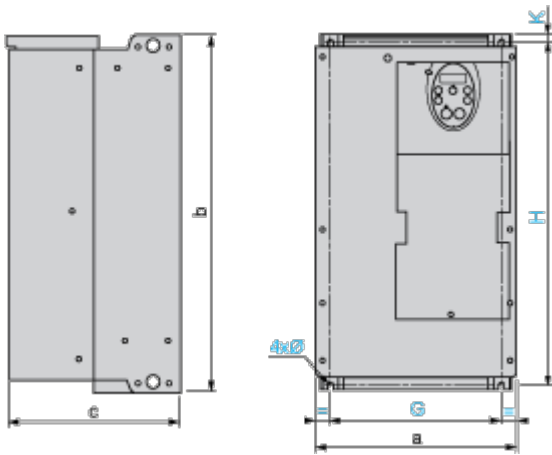

Dimensions in mm

ATV212H	a	b	c	G	H	K	Ø
D22M3X D22N4, D30N4	240	420	214	206	403	10	6
D37N4, D45N4	240	550	244	206	529	10	6

Dimensions in in.

ATV212H	a	b	c	G	H	K	Ø
D22M3X D22N4, D30N4	9.45	16.54	8.43	8.11	15.87	0.39	0.24
D37N4, D45N4	9.45	21.65	9.60	8.11	20.83	0.39	0.24

EMC mounting plate (supplied with drive)

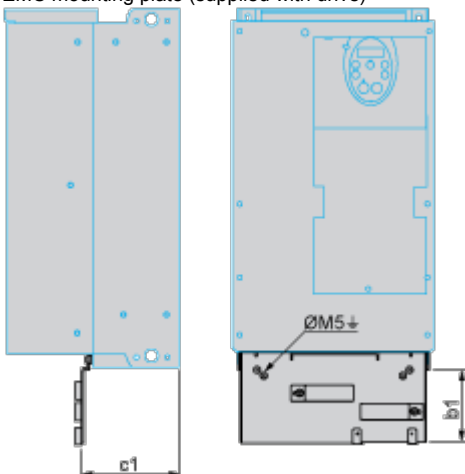

Dimensions in mm

ATV212H	b1	c1
D22M3X D22N4, D30N4	122	120
D37N4, D45N4	113	127

Dimensions in in.

ATV212H	b1	c1
D22M3X D22N4, D30N4	4.80	4.72
D37N4, D45N4	4.45	5.00

Mounting and Clearance

Mounting Recommendations

Clearance

Depending on the conditions in which the drive is to be used, its installation will require certain precautions and the use of appropriate accessories.

Install the unit vertically:

- Do not place it close to heating elements.
- Leave sufficient free space to ensure that the air required for cooling purposes can circulate from bottom to the top of the unit.

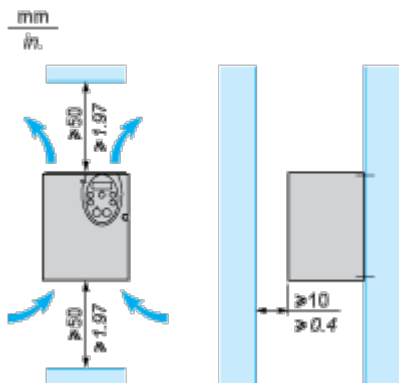

Mounting Types

Type A mounting

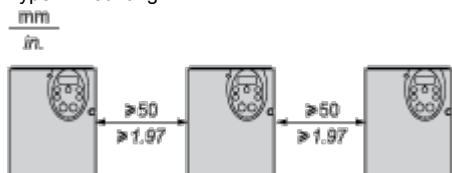

Type B mounting

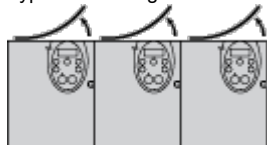

Type C mounting

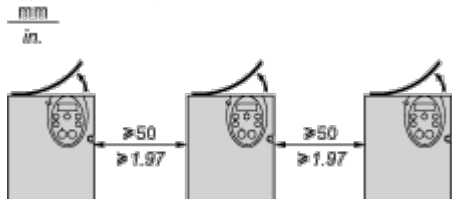

By removing the protective blanking cover from the top of the drive, the degree of protection for the drive becomes IP21. The protective blanking cover may vary according to the drive model, see opposite.

Specific Recommendations for Mounting in an Enclosure

To help ensure proper air circulation in the drive:

- Fit ventilation grilles.
- Check that there is sufficient ventilation. If there is not, install a forced ventilation unit with a filter. The openings and/or fans must provide a flow rate at least equal to that of the drive fans (refer to the product characteristics).

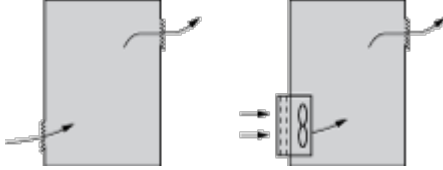

- Use special filters with UL Type 12/IP54 protection.
- Remove the blanking cover from the top of the drive.

Sealed Metal Enclosure (IP54 Degree of Protection)

The drive must be mounted in a dust and damp proof enclosure in certain environmental conditions, such as dust, corrosive gases, high humidity with risk of condensation and dripping water, splashing liquid, etc. This enables the drive to be used in an enclosure where the maximum internal temperature reaches 50°C.

Connections and Schema

Recommended Wiring Diagram

3-Phase Power Supply

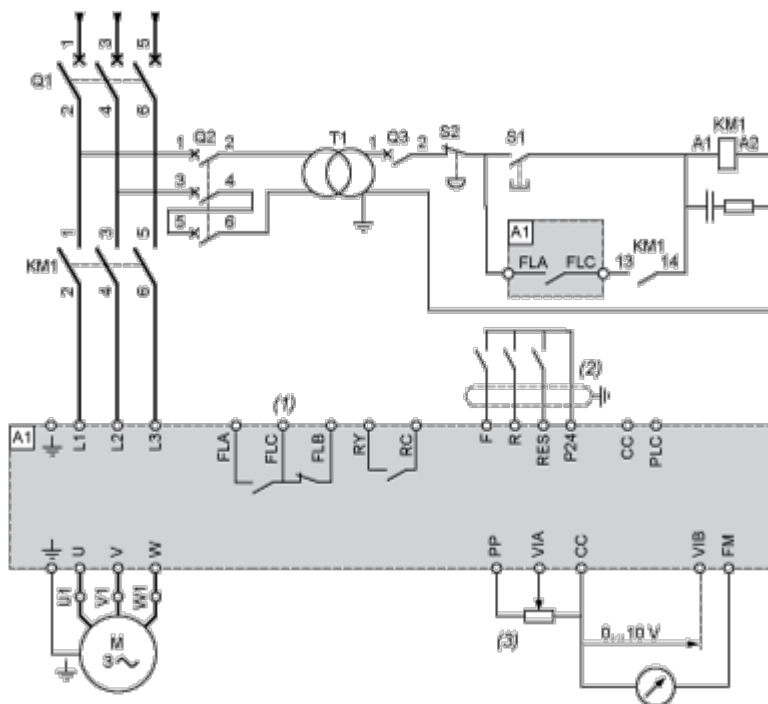

A1: ATV 212 drive

KM1: Contactor

Q1: Circuit breaker

Q2: GV2 L rated at twice the nominal primary current of T1

Q3: GB2CB05

S1, S2: XB4 B or XB5 A pushbuttons

T1: 100 VA transformer 220 V secondary

(1) Fault relay contacts for remote signalling of the drive status

(2) Connection of the common for the logic inputs depends on the positioning of the switch (Source, PLC, Sink)

(3) Reference potentiometer SZ1RV1202

NOTE: All terminals are located at the bottom of the drive. Install interference suppressors on all inductive circuits near the drive or connected on the same circuit, such as relays, contactors, solenoid valves, fluorescent lighting, etc.

Switches (Factory Settings)

Voltage/current selection for analog I/O (VIA and VIB)



Voltage/current selection for analog I/O (FM)



Selection of logic type



(1) negative logic

(2) positive logic

Other Possible Wiring Diagrams

Logic Inputs According to the Position of the Logic Type Switch

“Source” position

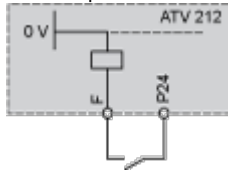

“Sink” position

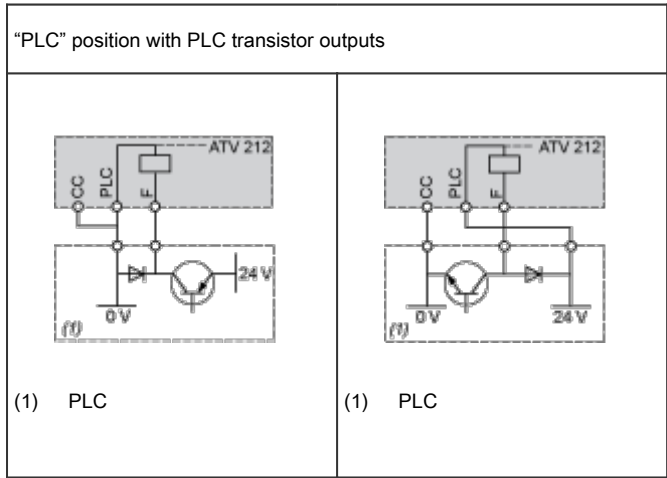
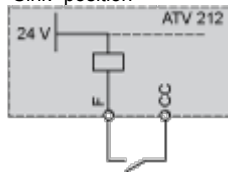

2-wire control

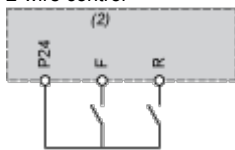

F: Forward

R: Preset speed

(2) ATV 212 control terminals

3-wire control

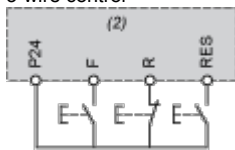

F: Forward

R: Stop

RES: Reverse

(2) ATV 212 control terminals

PTC probe



- (2) ATV 212 control terminals
- (3) Motor

Analog Inputs

Voltage analog inputs

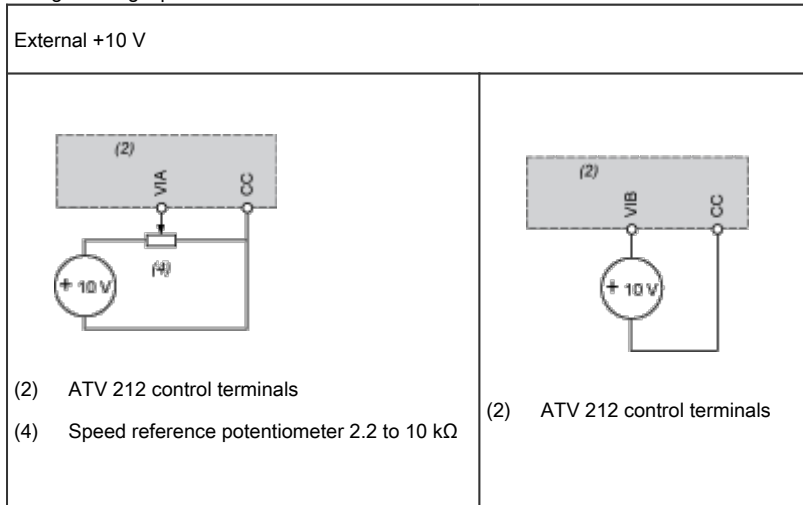

Analog input configured for current: 0-20 mA, 4-20 mA, X-Y mA

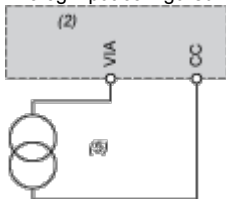

- (2) ATV 212 control terminals
- (5) Source 0-20 mA, 4-20 mA, X-Y mA

Analog input VIA configured as positive logic input ("Source" position)

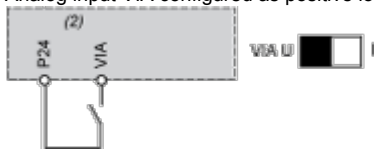

- (2) ATV 212 control terminals

Analog input VIA configured as negative logic input ("Sink" position)

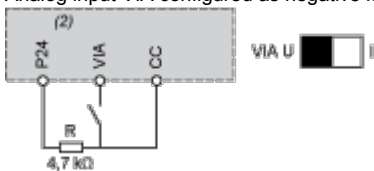

- (2) ATV 212 control terminals

Performance Curves

Derating Curves

The derating curves for the drive nominal current (I_n) depend on the temperature, the switching frequency and the mounting type (A, B or C).

For intermediate temperatures (45°C for example), interpolate between 2 curves.

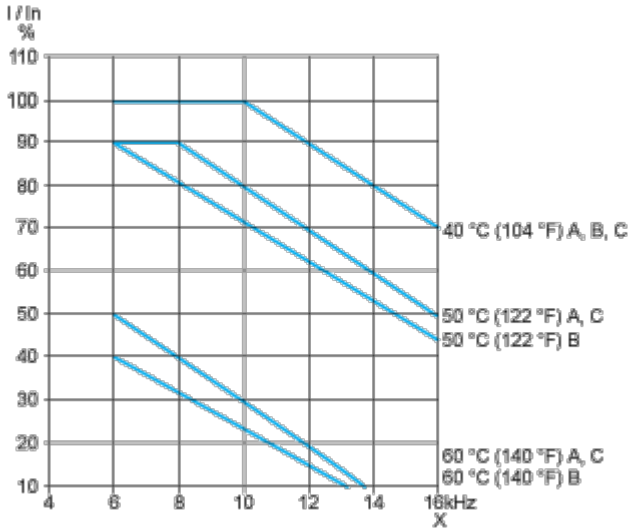

X Switching frequency

Image of product / Alternate images

Alternative

